

# Haptic Rendering of Textures



Katherine J. Kuchenbecker and Heather Culbertson  
Mechanical Engineering and Applied Mechanics  
Haptics Group, GRASP Lab





Katherine J. Kuchenbecker, Ph.D.  
Associate Professor



Heather Culbertson  
Ph.D. Candidate



Penn  
Haptics

# We love textures and haptic texture rendering.

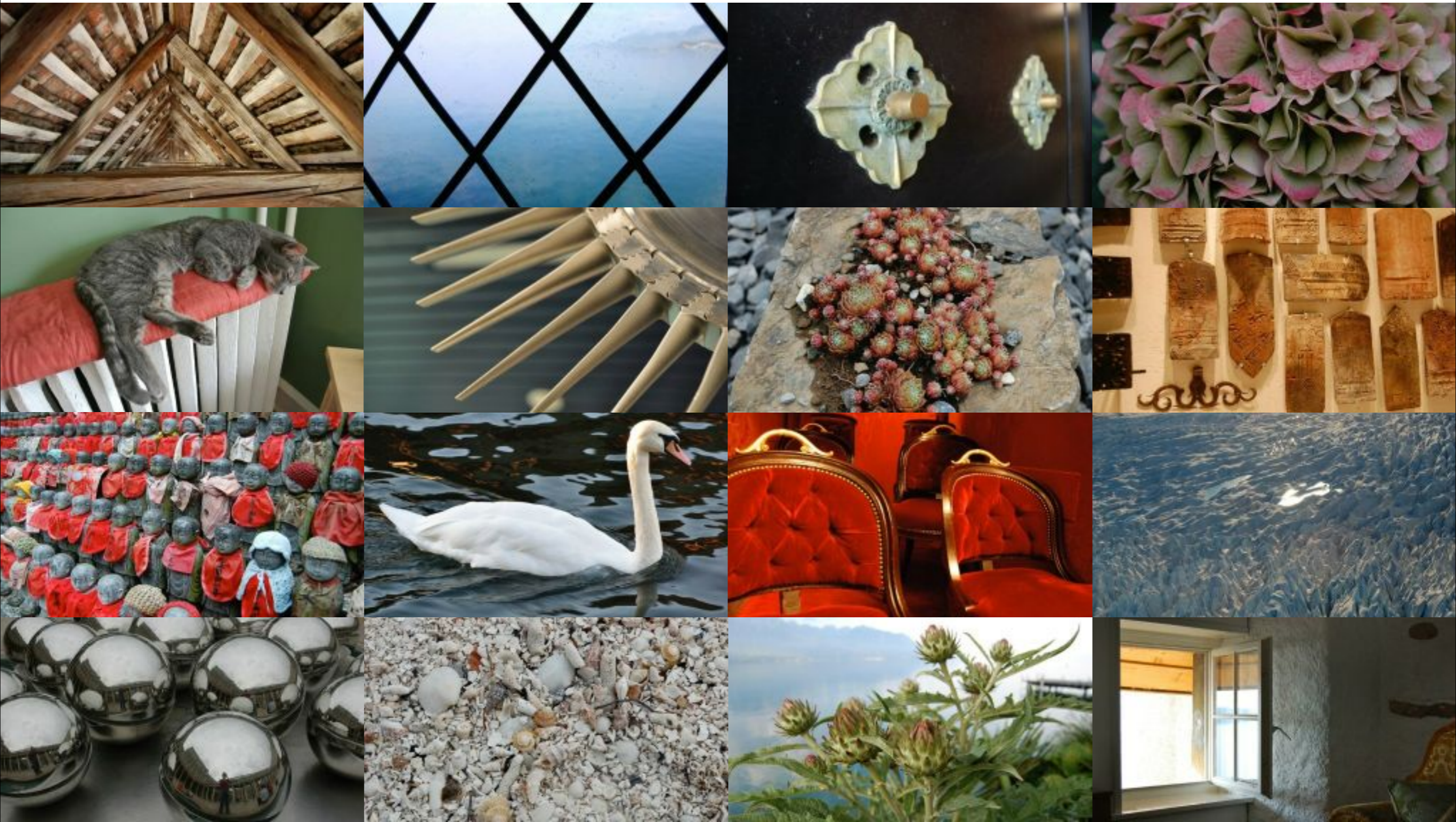

# Who are you?

Please introduce yourself:

Name

Institution

Position

Please ask questions throughout the tutorial!

# Haptic Rendering of Textures

Katherine J. Kuchenbecker and Heather Culbertson  
kuchenbe@seas.upenn.edu      hculb@seas.upenn.edu

Haptics Group, GRASP Laboratory  
Mechanical Engineering and Applied Mechanics  
University of Pennsylvania, USA

February 23, 2014: 1:30 p.m. – 5:00 p.m.  
IEEE Haptics Symposium  
Houston, Texas, USA

## Overview

This half-day Sunday afternoon tutorial will overview the problem of haptic texture rendering and then carefully explain a new set of methods the presenters have developed for creating highly realistic haptic virtual textures. While some of the discussion will be relevant to bare-finger haptic interactions, we will focus on situations where the user touches the surface through a rigid tool. Interestingly, even though the skin is not in contact with the surface, humans can perceive many properties of a texture by dragging a rigid tool across it. Such interactions frequently arise in the areas of art, design, manufacturing, and medicine, as well as in everyday tasks such as writing a grocery list.

## Agenda

- 1:30 – 1:40 Introductions
- 1:40 – 1:55 Activity 1: Passive and active interaction with textures using a tool and the fingertip (KJK)
- 1:55 – 2:10 Perception of Textures (HC)
- 2:10 – 2:20 Background on Texture Rendering (KJK)
- 2:20 – 2:30 Data-Driven Modeling (KJK)
- 2:30 – 2:45 Activity 2: Passive tool-mediated interaction with textures moving slow/fast and pressing hard/soft (KJK)
- 2:45 – 3:00 Recording Hardware and Demo 1: Haptic Camera (HC)
  
- 3:00 – 3:30 Coffee Break: Demos will be available during this time
  
- 3:30 – 3:40 Friction Modeling (HC)
- 3:40 – 3:55 Texture Modeling (HC)
- 3:55 – 4:05 Texture Signal Generation (KJK)
- 4:05 – 4:25 Rendering Hardware and Demo 2: TexturePad (KJK)
- 4:25 – 4:40 Perception of Virtual Textures (HC)
- 4:40 – 5:00 Penn Haptic Texture Toolkit and Demo 3: Toolkit Textures on Omni (HC)  
[http://repository.upenn.edu/meam\\_papers/299/](http://repository.upenn.edu/meam_papers/299/)

## References

- [1] Allison M. Okamura, Katherine J. Kuchenbecker, and Mohsen Mahvash. Measurement-based modeling for haptic rendering. In Ming Lin and Miguel Otaduy, editors, *Haptic Rendering: Algorithms and Applications*, chapter 21, pp. 443–467. A. K. Peters, May 2008.
- [2] Katherine J. Kuchenbecker, Joseph M. Romano, and William McMahan. Haptography: Capturing and recreating the rich feel of real surfaces. In Cédric Pradalier, Roland Siegwart, and Gerhard Hirzinger, editors, *Robotics Research: the 14th International Symposium (ISRR 2009)*, volume 70 of *Springer Tracts in Advanced Robotics*, pp. 245–260. Springer, 2011.
- [3] William McMahan and Katherine J. Kuchenbecker. Haptic display of realistic tool contact via dynamically compensated control of a dedicated actuator. In *Proc. IEEE/RSJ International Conference on Intelligent Robots and Systems*, pp. 3171–3177. St. Louis, Missouri, USA, October 2009.
- [4] William McMahan, Joseph M. Romano, Amal M. Abdul Rahuman, and Katherine J. Kuchenbecker. High frequency acceleration feedback significantly increases the realism of haptically rendered textured surfaces. In *Proc. IEEE Haptics Symposium*, pp. 141–148. Waltham, Massachusetts, March 2010.
- [5] Joseph M. Romano, Takashi Yoshioka, and Katherine J. Kuchenbecker. Automatic filter design for synthesis of haptic textures from recorded acceleration data. In *Proc. IEEE International Conference on Robotics and Automation*, pp. 1815–1821. May 2010.
- [6] Nils Landin, Joseph M. Romano, William McMahan, and Katherine J. Kuchenbecker. Dimensional reduction of high-frequency accelerations for haptic rendering. In Astrid Kappers, Jan van Erp, Wouter Bergmann Tiest, and Frans van der Helm, editors, *Haptics: Generating and Perceiving Tangible Sensations, Proc. EuroHaptics, Part II*, volume 6192 of *Lecture Notes in Computer Science*, pp. 79–86. Springer, July 2010.
- [7] Heather Culbertson, Joseph M. Romano, Pablo Castillo, Max Mintz, and Katherine J. Kuchenbecker. Refined methods for creating realistic haptic virtual textures from tool-mediated contact acceleration data. In *Proc. IEEE Haptics Symposium*, pp. 385–391. March 2012.
- [8] Joseph M. Romano and Katherine J. Kuchenbecker. Creating realistic virtual textures from contact acceleration data. *IEEE Transactions on Haptics*, volume 5(2):pp. 109–119, April-June 2012.
- [9] Heather Culbertson, Juliette Unwin, Benjamin E. Goodman, and Katherine J. Kuchenbecker. Generating haptic texture models from unconstrained tool-surface interactions. In *Proc. IEEE World Haptics Conference*, pp. 295–300. April 2013.
- [10] Craig G. McDonald and Katherine J. Kuchenbecker. Dynamic simulation of tool-mediated texture interaction. In *Proc. IEEE World Haptics Conference*, pp. 307–312. Daejeon, South Korea, April 2013.
- [11] Heather Culbertson, Juan José López Delgado, and Katherine J. Kuchenbecker. One hundred data-driven haptic texture models and open-source methods for rendering on 3D objects. In *Proc. IEEE Haptics Symposium*. February 2014.
- [12] William McMahan and Katherine J. Kuchenbecker. Dynamic modeling and control of voice-coil actuators for high-fidelity display of haptic vibrations. In *Proc. IEEE Haptics Symposium*. February 2014.
- [13] Heather Culbertson, Juliette Unwin, and Katherine J. Kuchenbecker. Modeling and rendering realistic textures from unconstrained tool-surface interactions, 2014. Under revisions for *IEEE Transactions on Haptics*.

# Activity 1

- Choose a partner.
- Obtain a chopstick and some texture samples.
- **Subject:** Hold the chopstick like a pen, fat end down, in the air, and close your eyes.
- Your job is to figure out what kind of texture you are touching, noticing the sensations.



# Activity 1

- **Experimenter:** Chose a texture and move it back and forth against the fat end of the chopstick.
- After a while, switch to holding the texture stationary and let your partner move the tool.
- Switch roles and pick a different texture.
- Also try the same activities using your bare finger.





# Reflections on Activity 1

- **Indirect touch:** interacting with a surface through an intermediary object.
- **Direct touch:** touching with your bare skin.
- **Passive touch:** when the surface moves and the tool or finger remains stationary.
- **Active touch:** when the subject moves.

What did you notice during this activity?

# Perception of Textures

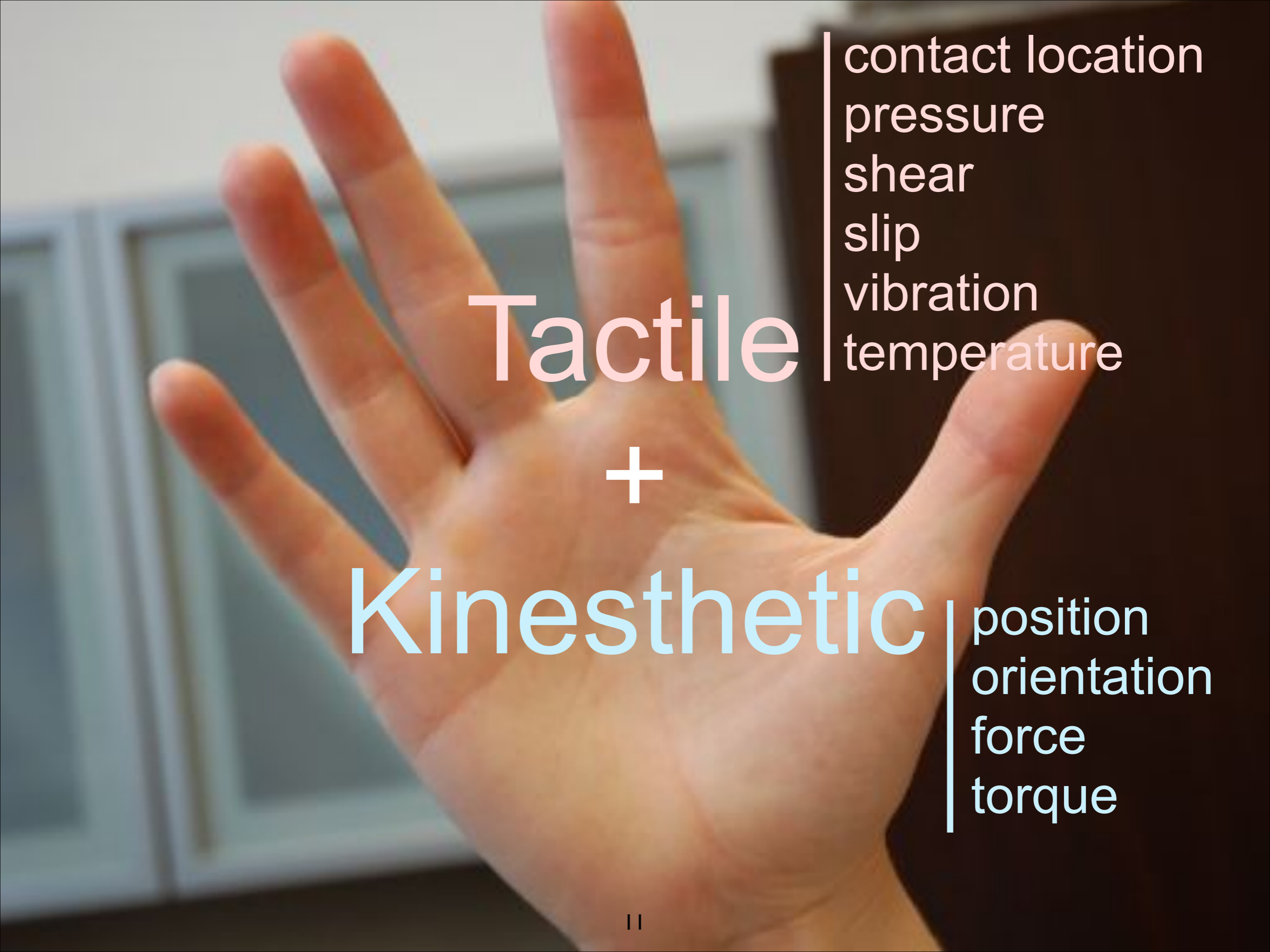

Tactile

contact location  
pressure  
shear  
slip  
vibration  
temperature

+

Kinesthetic

position  
orientation  
force  
torque

# Mechanoreceptors

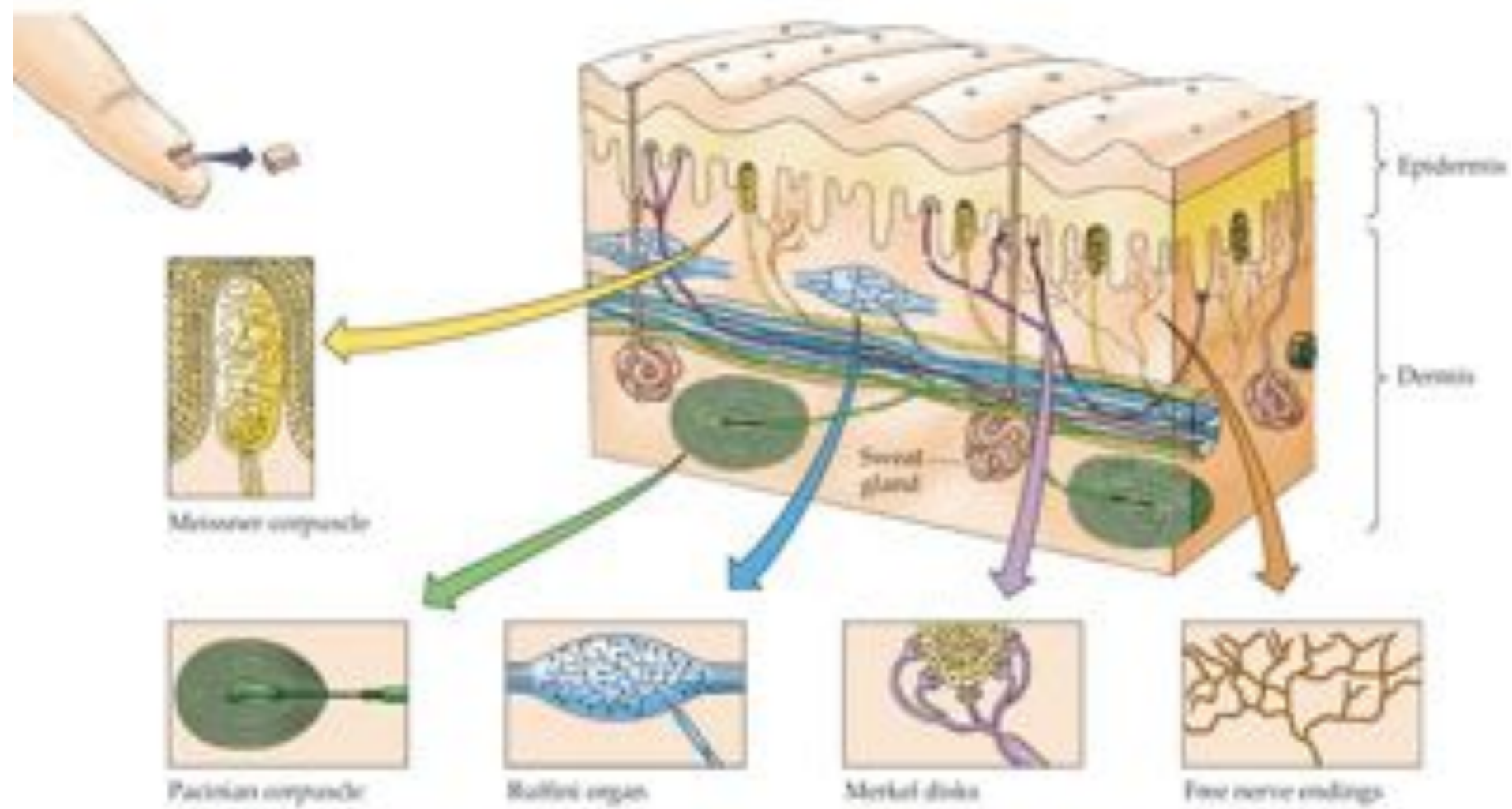

# Mechanoreceptors

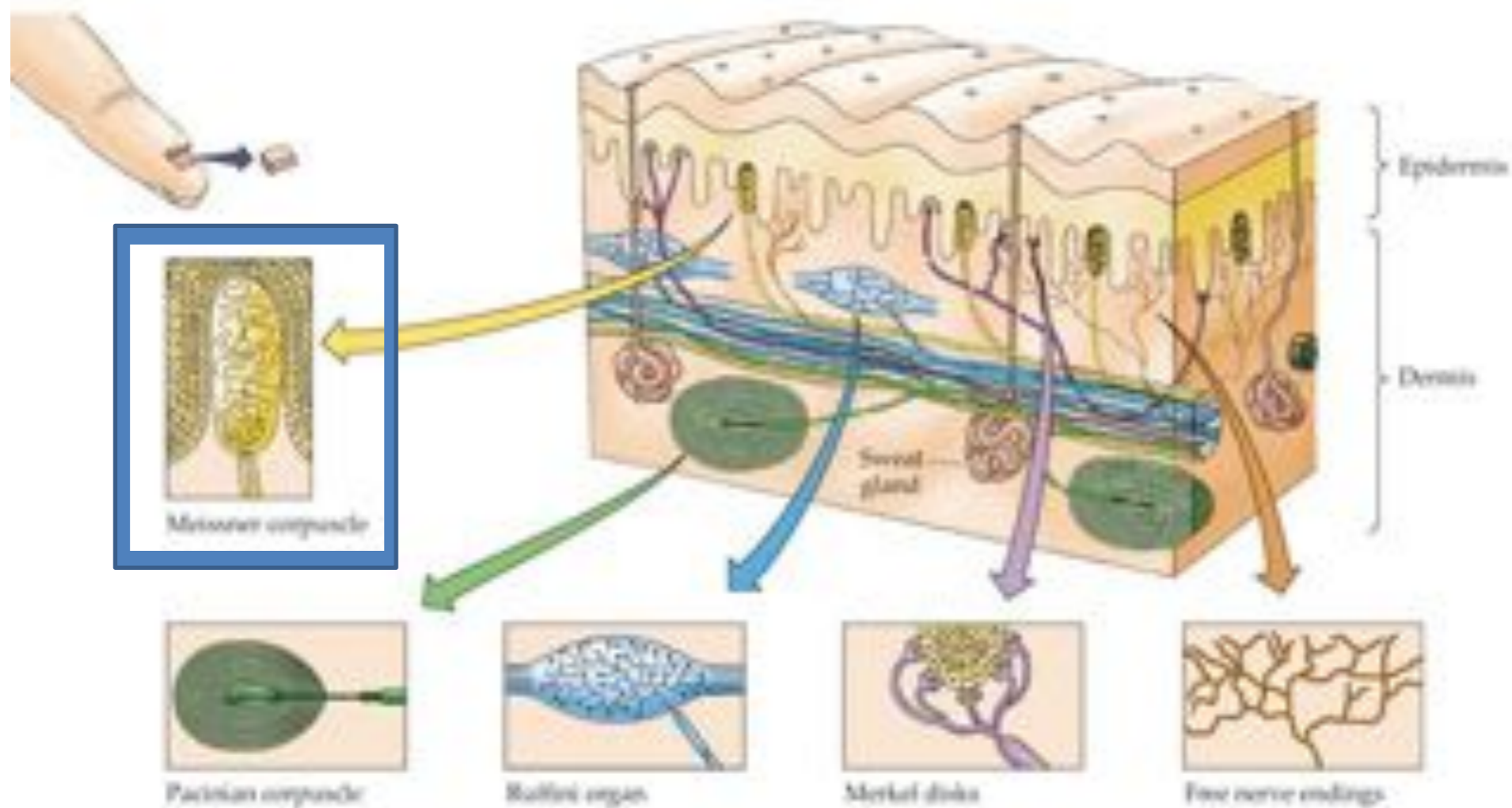

Afferent type (and response properties)	Receptive field (and probe)	Density (afferents per cm <sup>2</sup> )
FA-I (fast-adapting type I) Meissner endings <ul style="list-style-type: none"> <li>• Sensitive to dynamic skin deformation of relatively high frequency (~5–50 Hz)</li> <li>• Insensitive to static force</li> <li>• Transmit enhanced representations of local spatial discontinuities (e.g., edge contours and Braille-like stimuli)</li> </ul>	<p>Weak pointed touch</p>	

“Coding and use of tactile signals from the fingertips in object manipulation tasks” by Johansson and Flanagan, 2009

# Mechanoreceptors

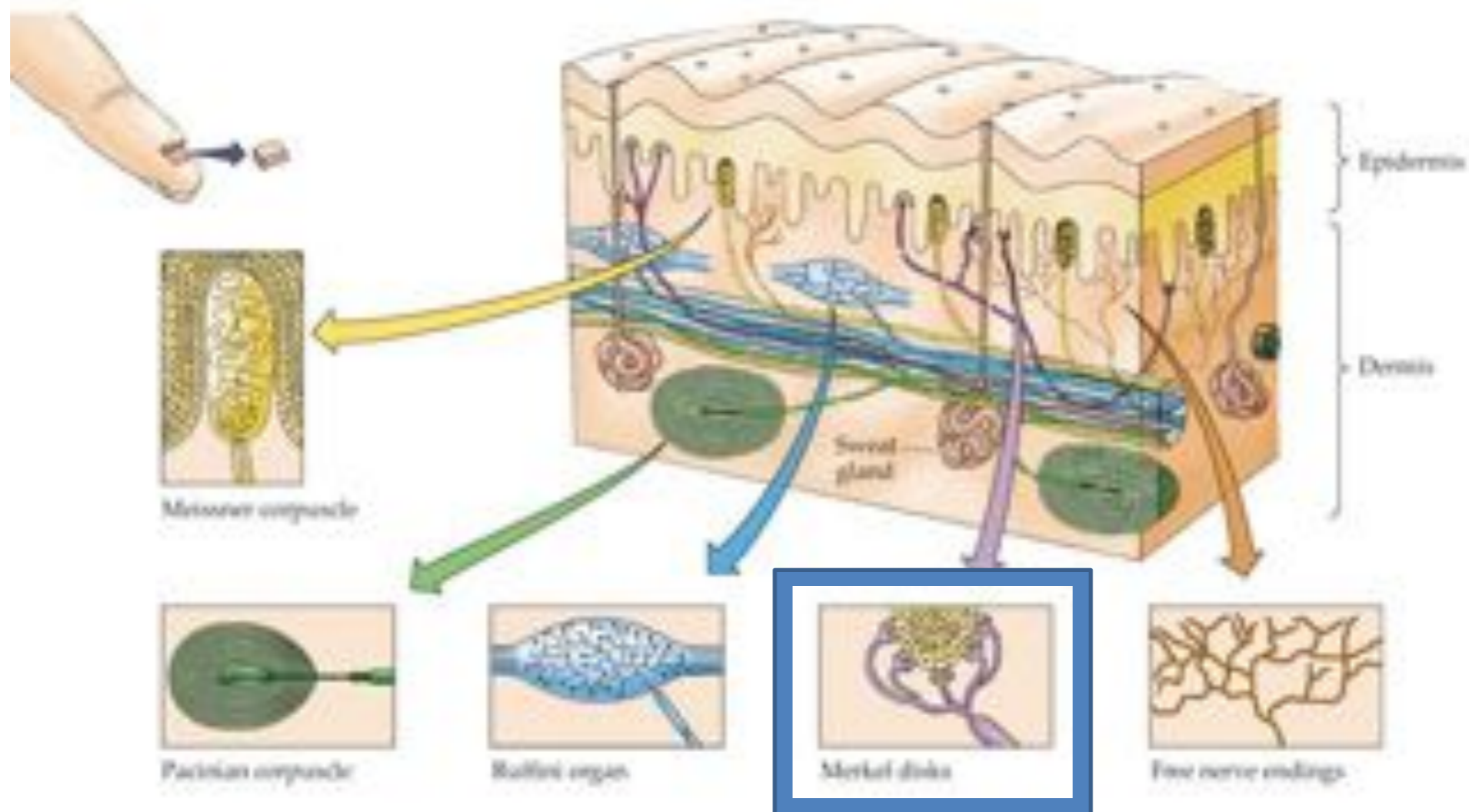

Afferent type (and response properties)	Receptive field (and probe)	Density (afferents per cm <sup>2</sup> )
SA-I (slowly-adapting type I) Merkel endings <ul style="list-style-type: none"> <li>• Sensitive to low-frequency dynamic skin deformations (&lt;math&gt;&lt; 5\text{ Hz}&lt;/math&gt;)</li> <li>• Sensitive to static force</li> <li>• Transmit enhanced representations of local spatial discontinuities</li> </ul>		

Weak pointed touch

“Coding and use of tactile signals from the fingertips in object manipulation tasks” by Johansson and Flanagan, 2009

# Mechanoreceptors

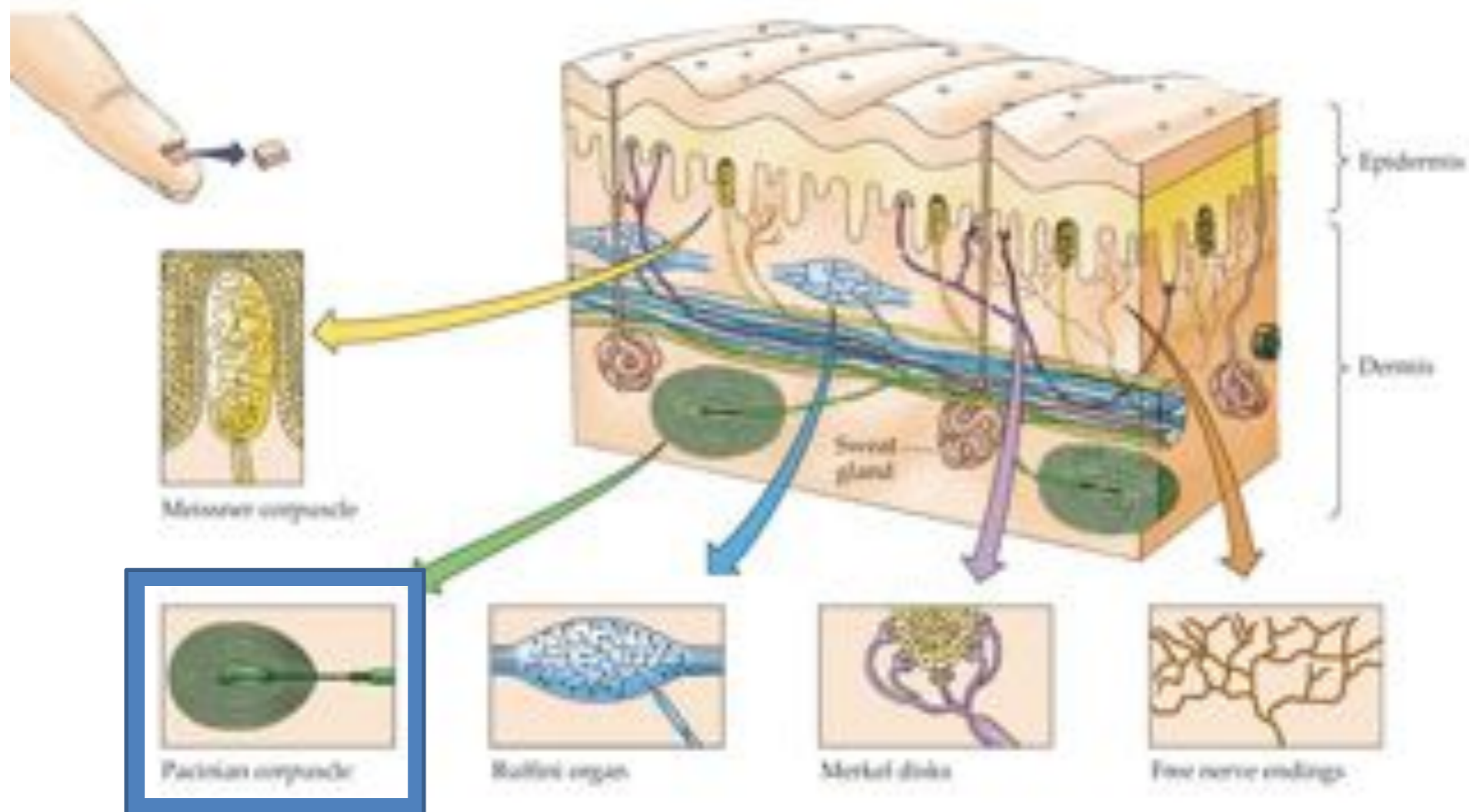

Afferent type (and response properties)	Receptive field (and probe)	Density (afferents per cm <sup>2</sup> )
--	--------------------------------	---

<p>FA-II (fast-adapting type II) Pacini ending</p> <ul style="list-style-type: none"> <li>• Extremely sensitive to mechanical transients and high-frequency vibrations (~40–400 Hz) propagating through tissues</li> <li>• Insensitive to static force</li> <li>• Respond to distant events acting on hand-held objects</li> </ul>		
--	--	--



Light tapping

“Coding and use of tactile signals from the fingertips in object manipulation tasks” by Johansson and Flanagan, 2009

# Mechanoreceptors

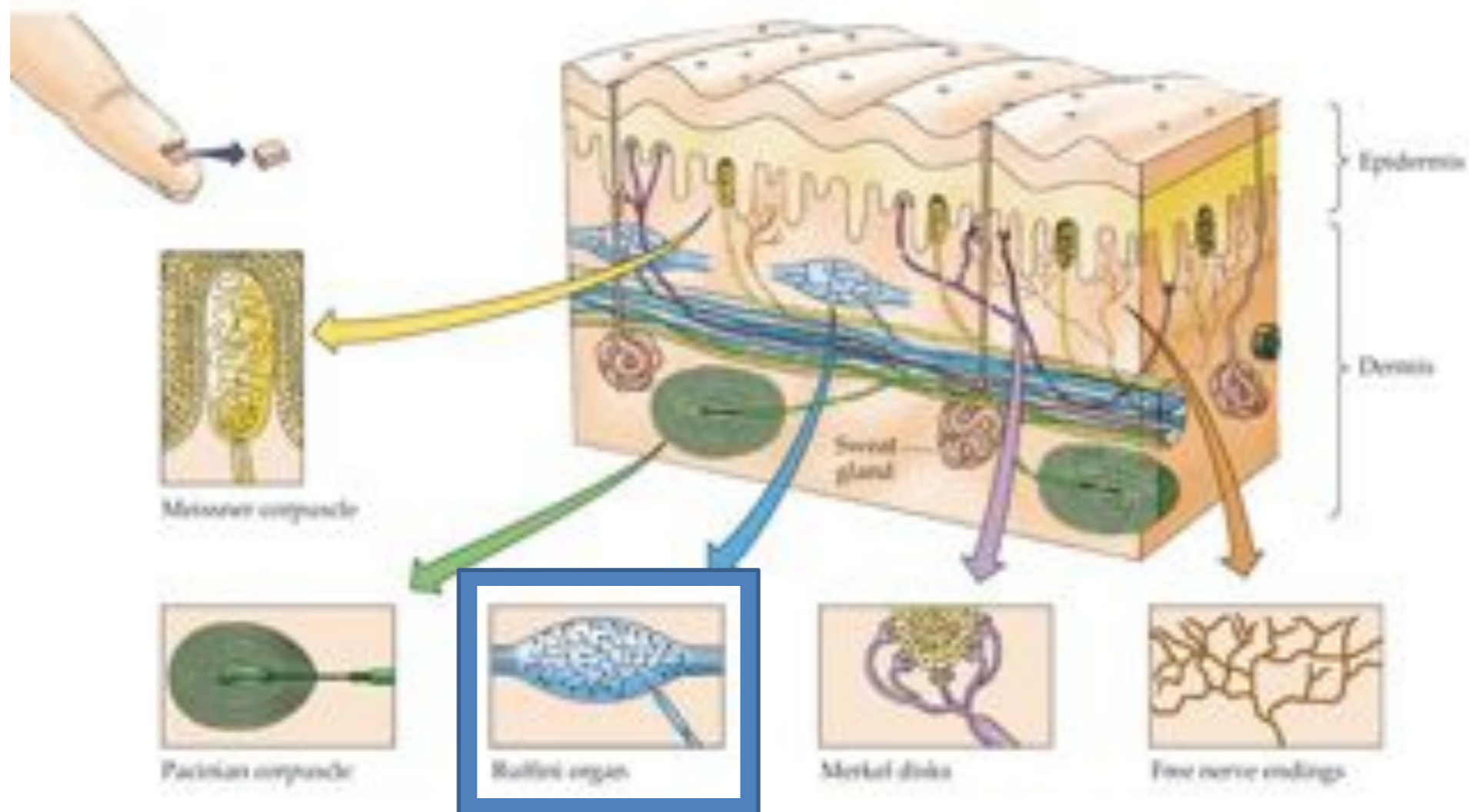

Afferent type (and response properties)	Receptive field (and probe)	Density (afferents per cm <sup>2</sup> )
SA-II (slowly-adapting type II) Ruffini-like endings <ul style="list-style-type: none"> <li>• Low dynamic sensitivity</li> <li>• Sensitive to static force</li> <li>• Sense tension in dermal and subcutaneous collagenous fibre strands</li> <li>• Can fire in the absence of externally applied stimulation and respond to remotely applied stretching of the skin</li> </ul>	<p>Touch or skin stretch</p>	

“Coding and use of tactile signals from the fingertips in object manipulation tasks” by Johansson and Flanagan, 2009



# Psychophysical Dimensions

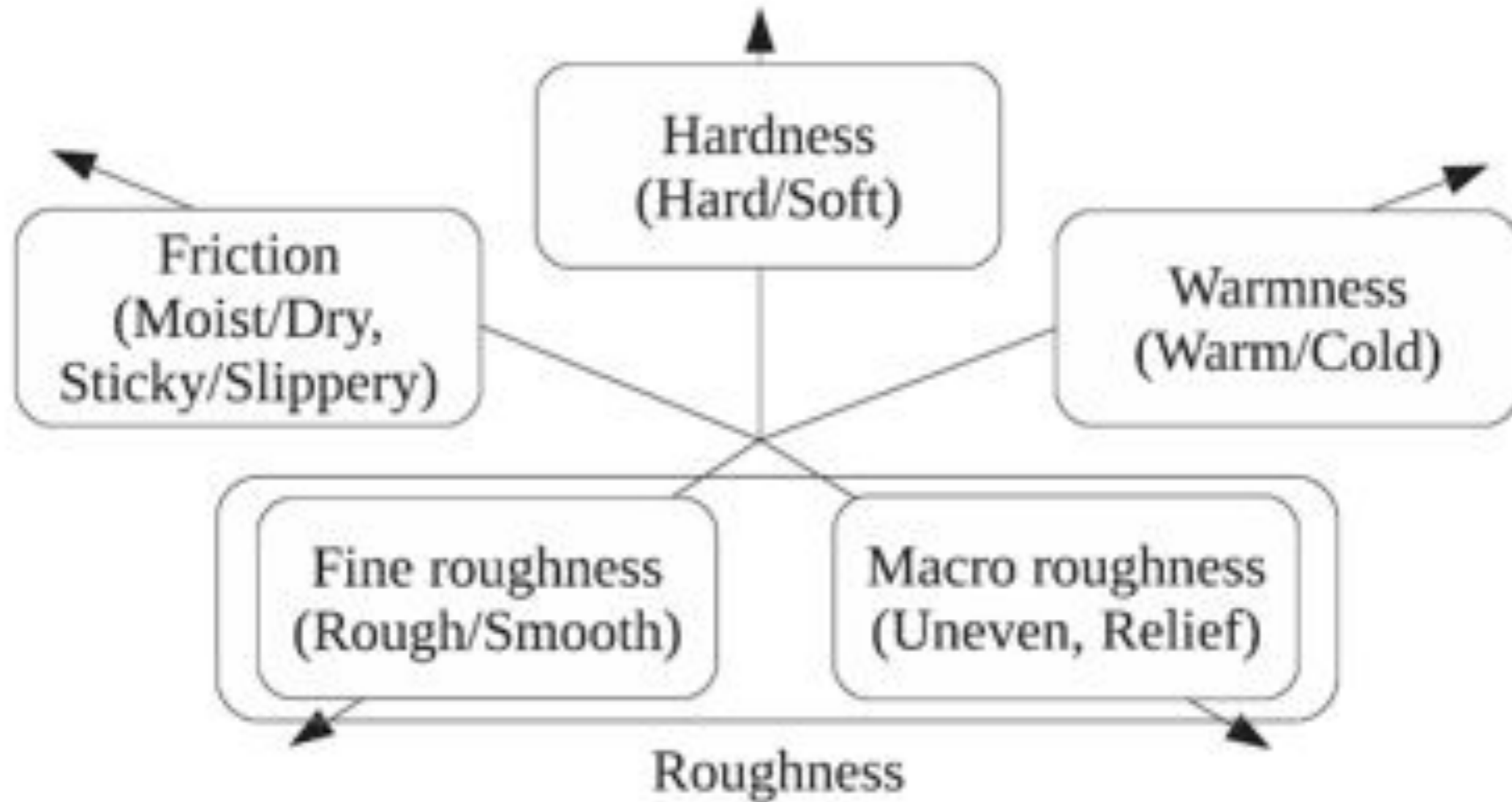

# Psychophysical Dimensions

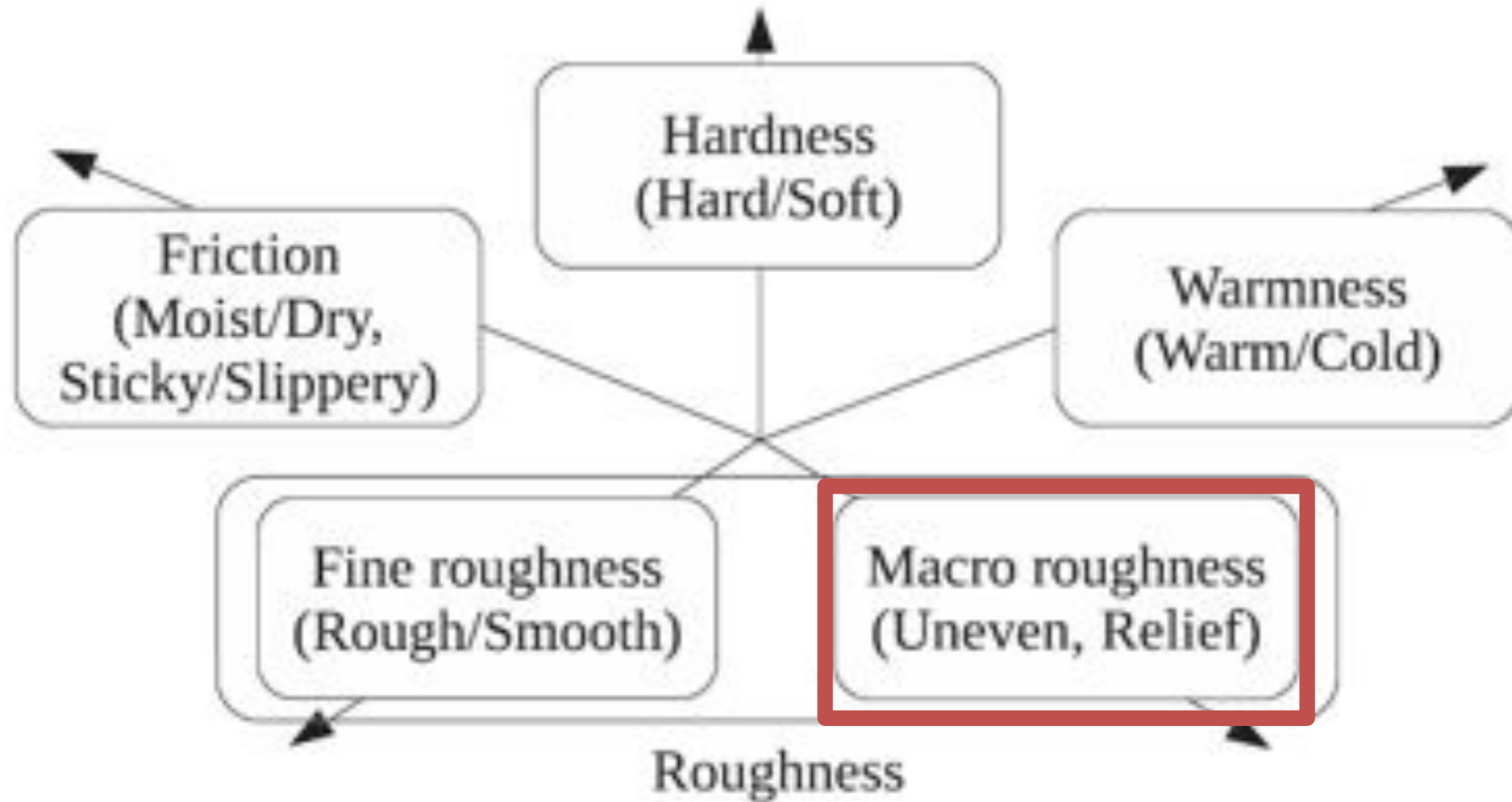

- Spatial distribution of SAI
- No temporal information

# Psychophysical Dimensions

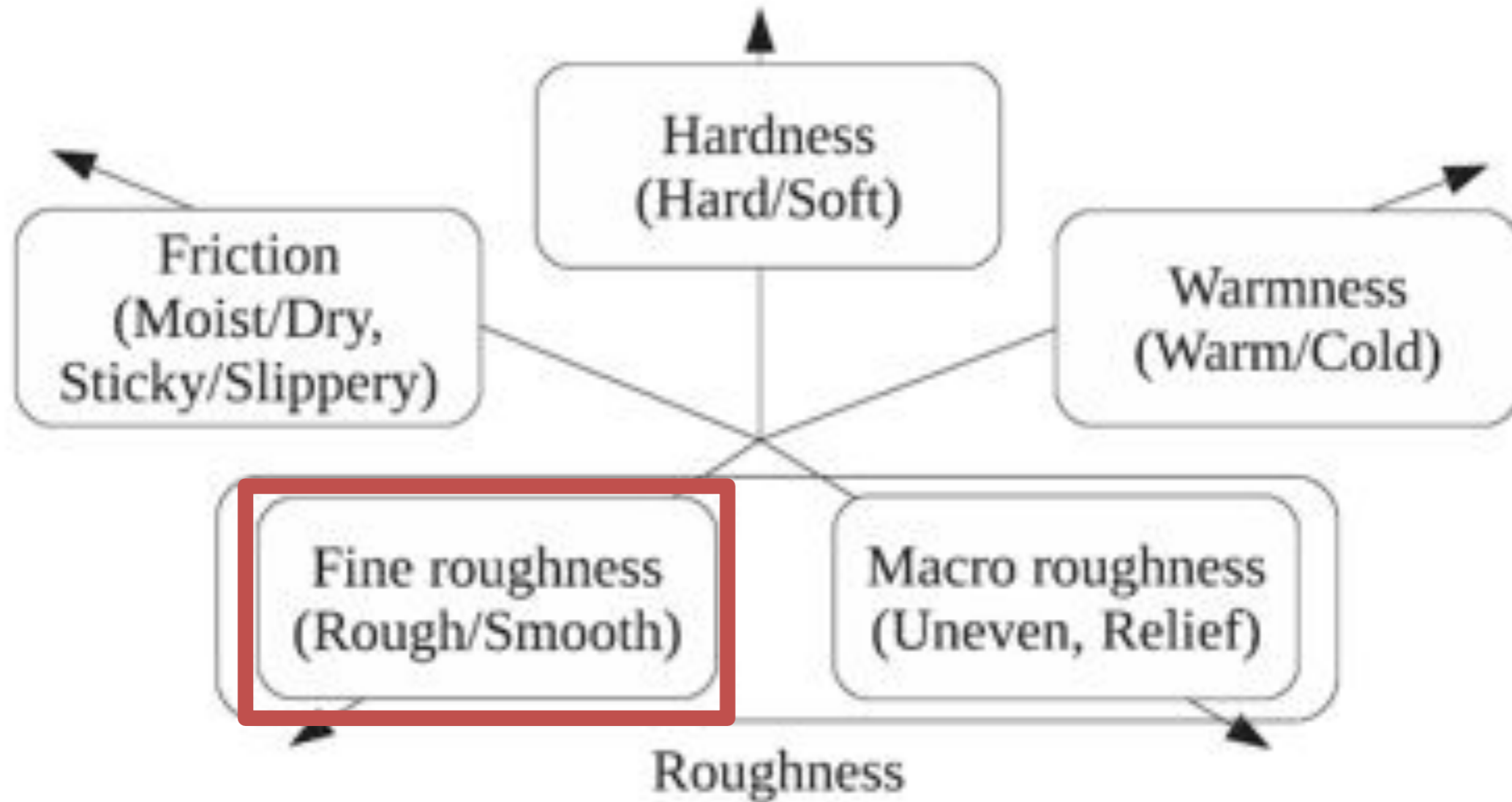

- Vibratory information  
– FAI and FAII

# Psychophysical Dimensions

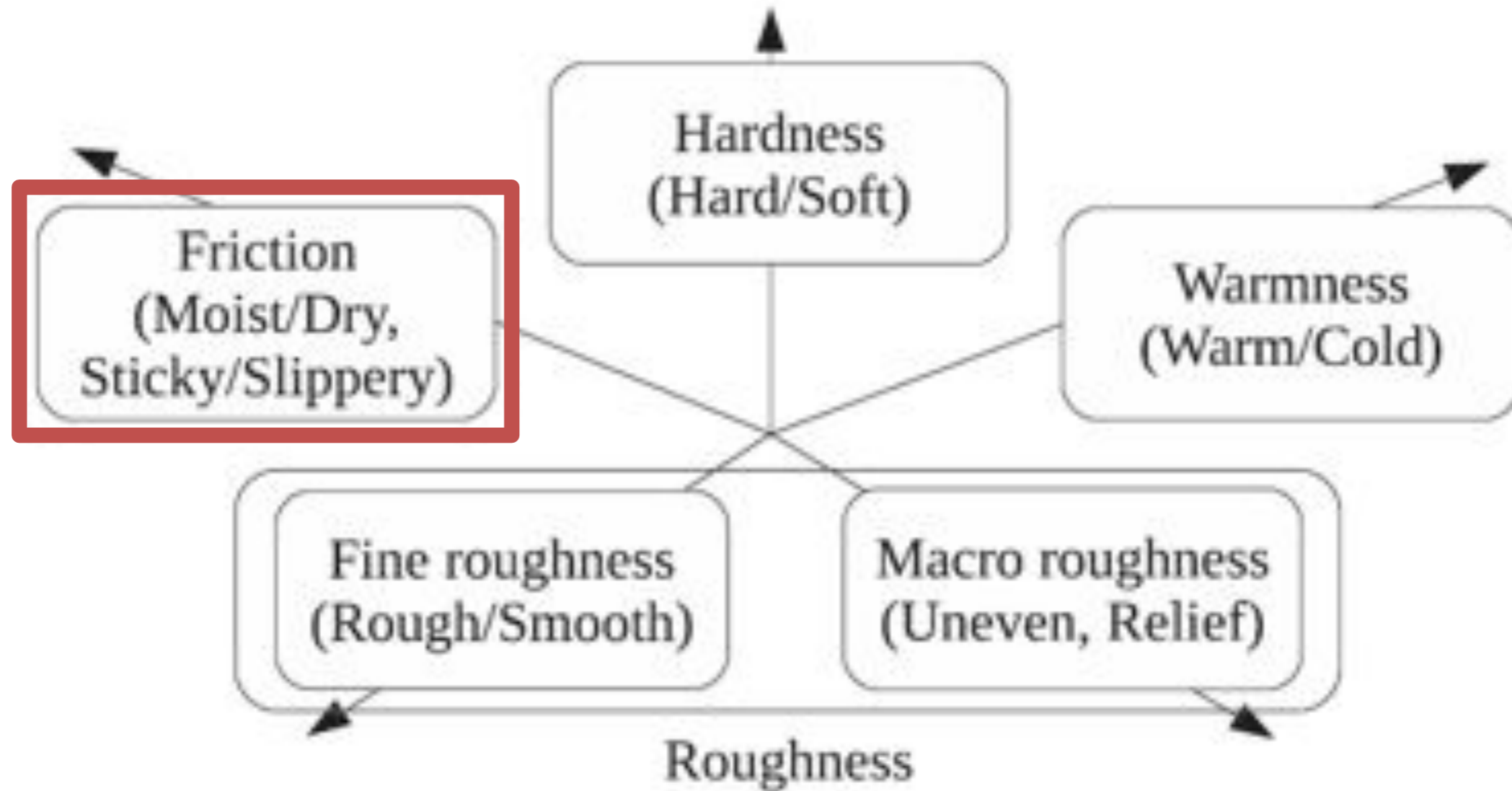

- Mediated by skin of finger pad  
– Skin stretch or adhesion

# Psychophysical Dimensions

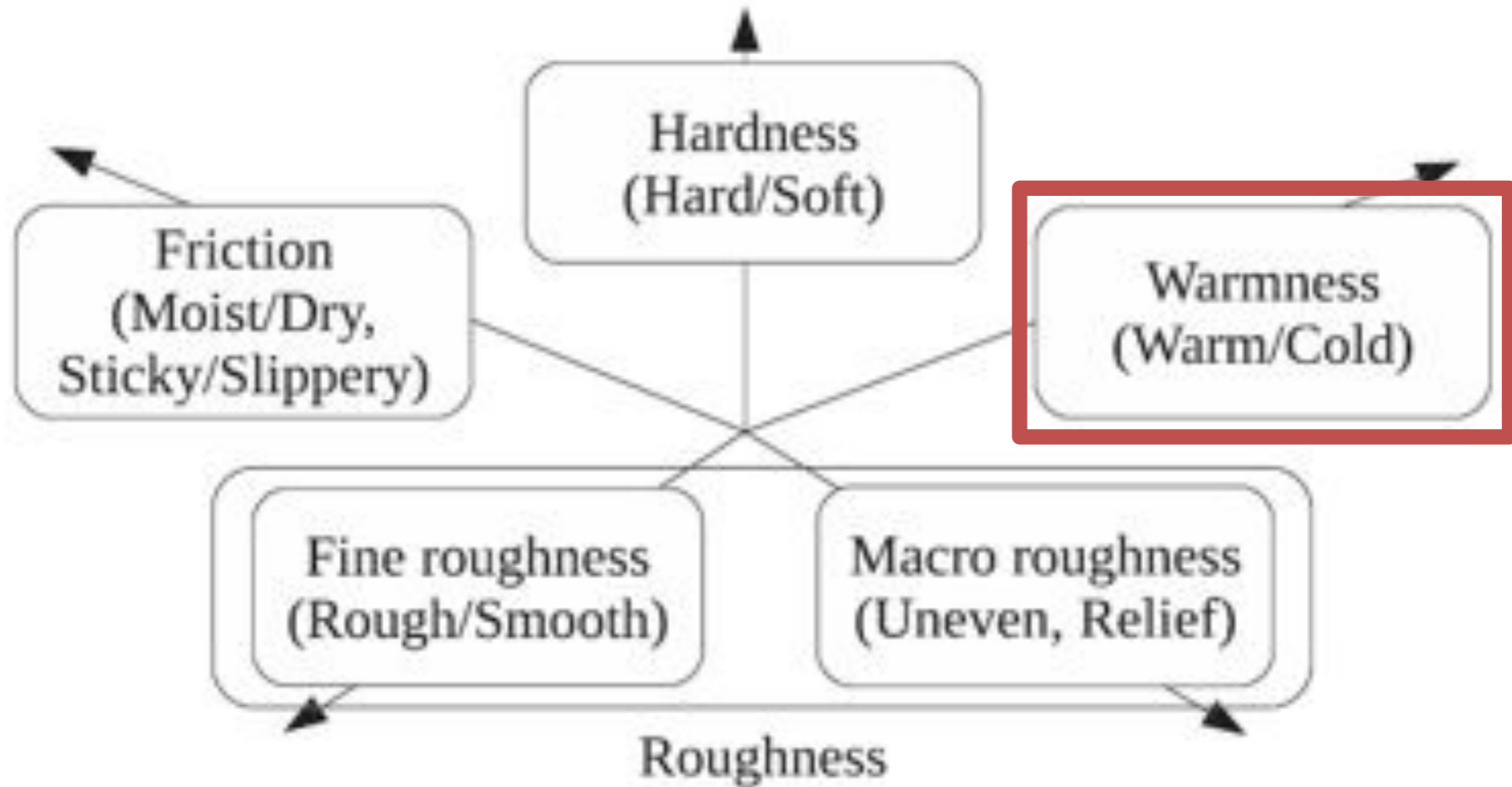

- Heat transfer property between texture and finger
- TRP ion-channels on free nerve endings

# Psychophysical Dimensions

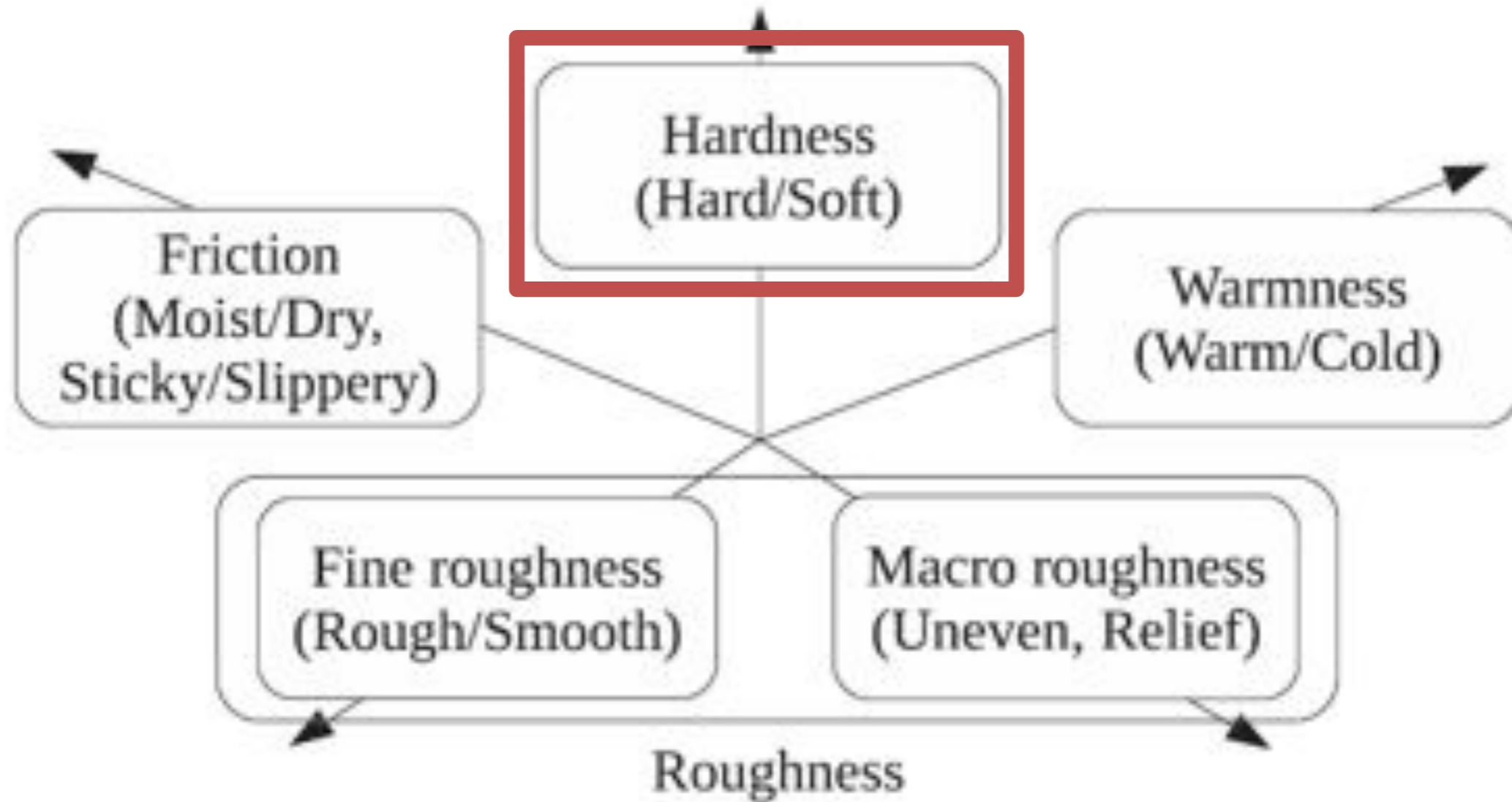

- Tactile cues
- Contact area between finger pad and object is important

# Perception through a tool

- Rigid link between surface and fingers
- No spatial cues available
  - Skin deformation from tool, not from surface
- Vibratory stimuli
- Warm/cool dimension cannot be conveyed



# Roughness through a tool

- High correlation of rated roughness values between finger and tool
- Perceived roughness increased as power of vibrations increased

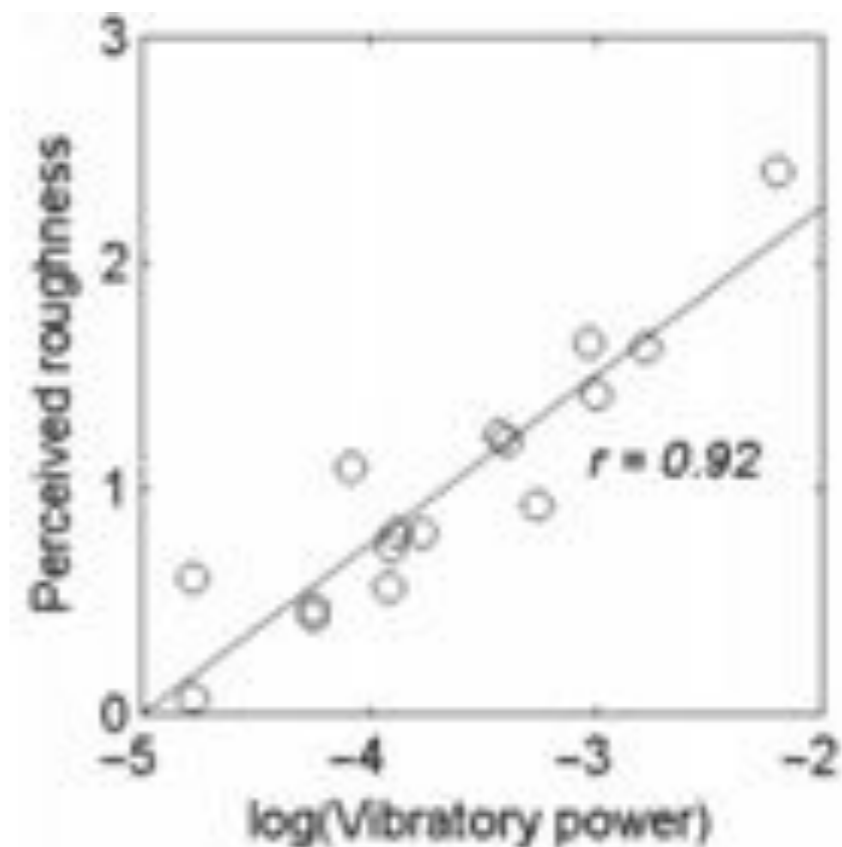
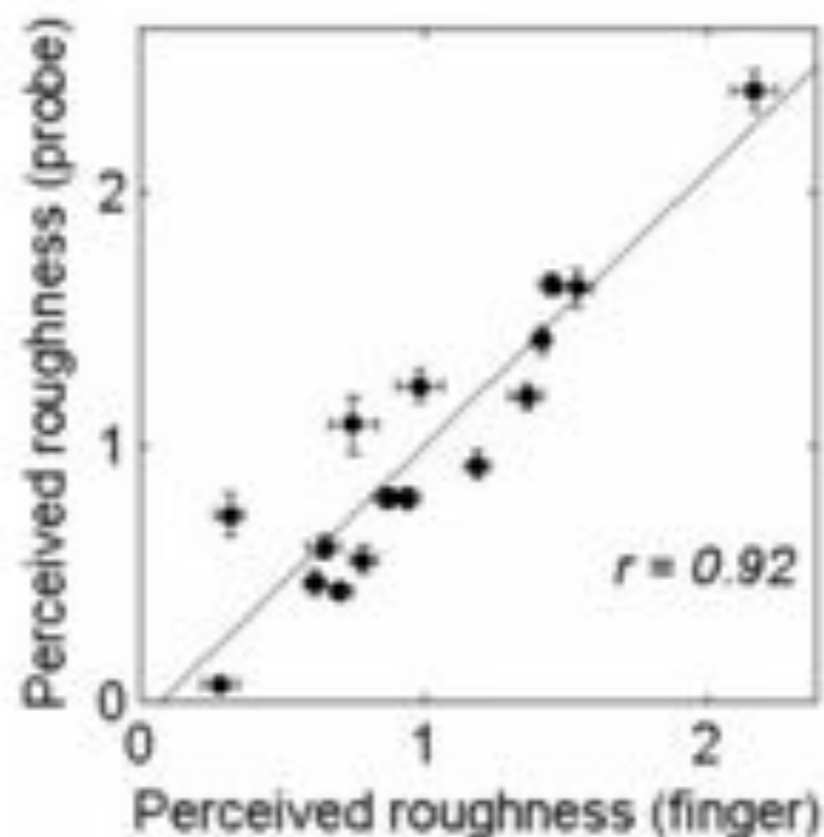

“Texture Perception Through Direct and Indirect Touch: An Analysis of Perceptual Space for Tactile Textures in Two Modes of Exploration” by Yoshioka et al., 2007



# Stickiness through a tool

- Proprioceptive cues through tool
- Perceived stickiness increased as friction between probe and texture increased

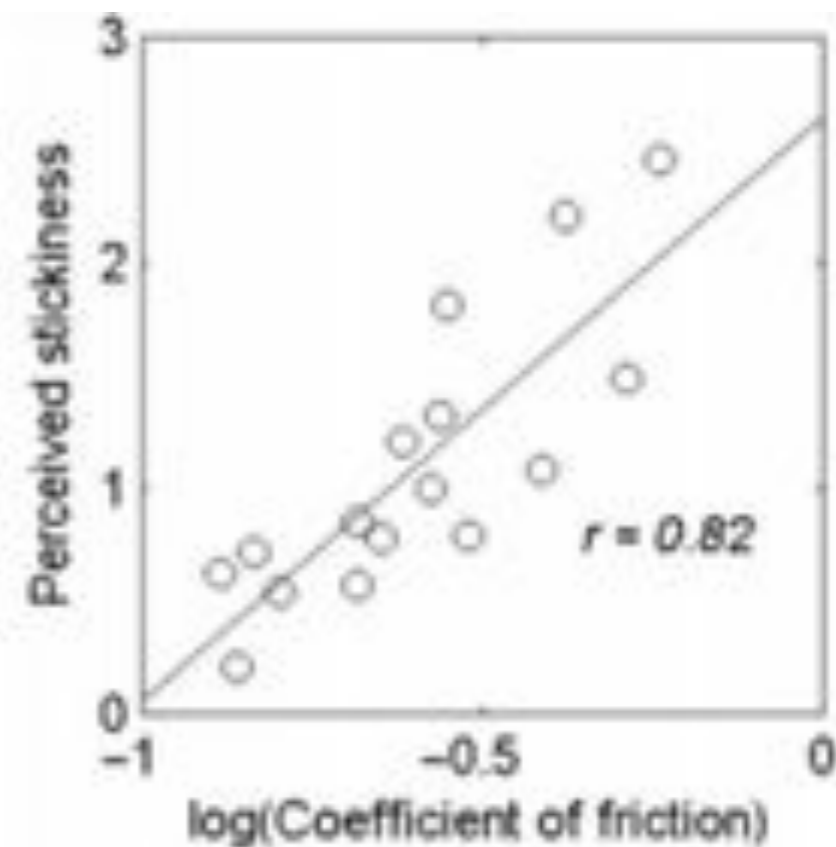
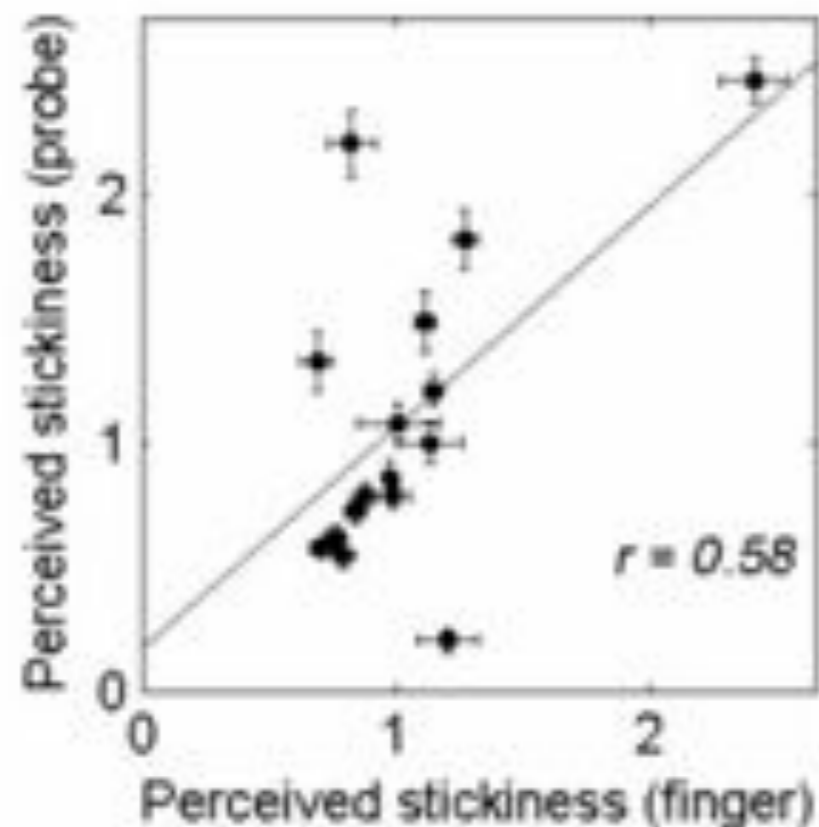

“Texture Perception Through Direct and Indirect Touch: An Analysis of Perceptual Space for Tactile Textures in Two Modes of Exploration” by Yoshioka et al., 2007

# Hardness through a tool

- Proprioceptive cues through tool
  - Amount of surface indentation (SAII)
- Perceived hardness decreased as compliance increased

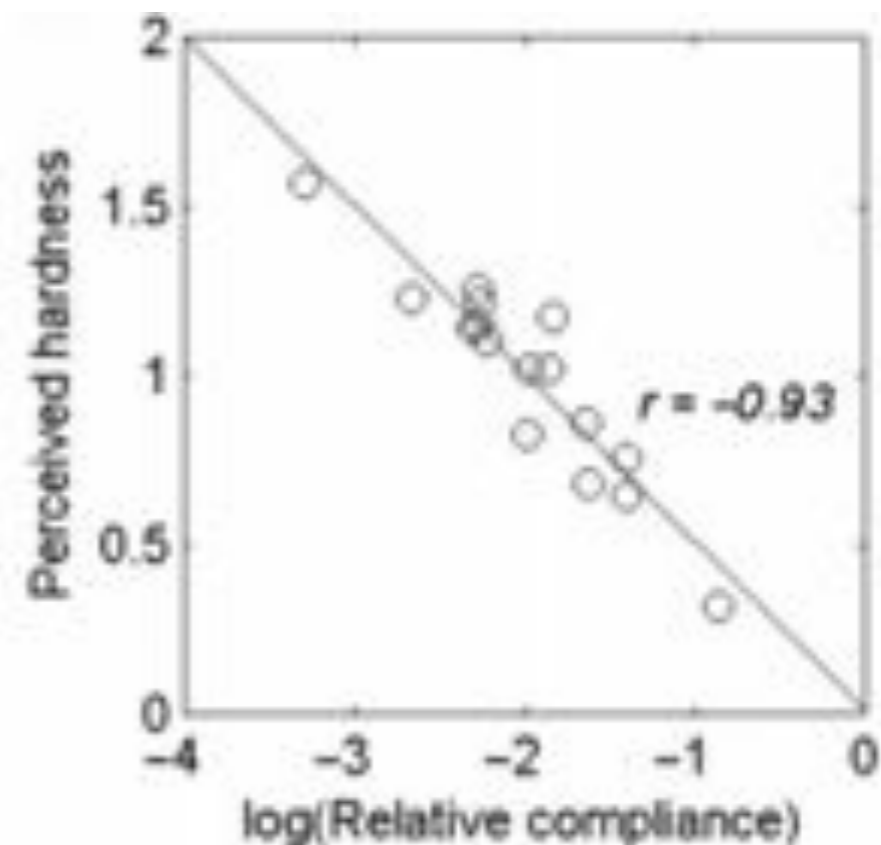
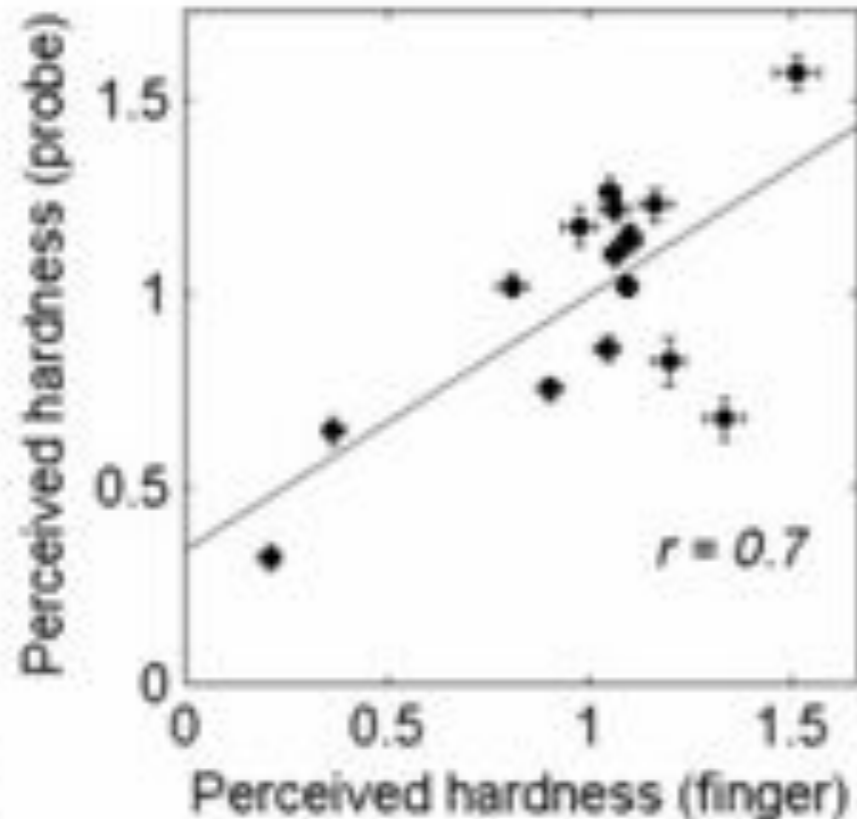

“Texture Perception Through Direct and Indirect Touch: An Analysis of Perceptual Space for Tactile Textures in Two Modes of Exploration” by Yoshioka et al., 2007



# Background on Texture Rendering

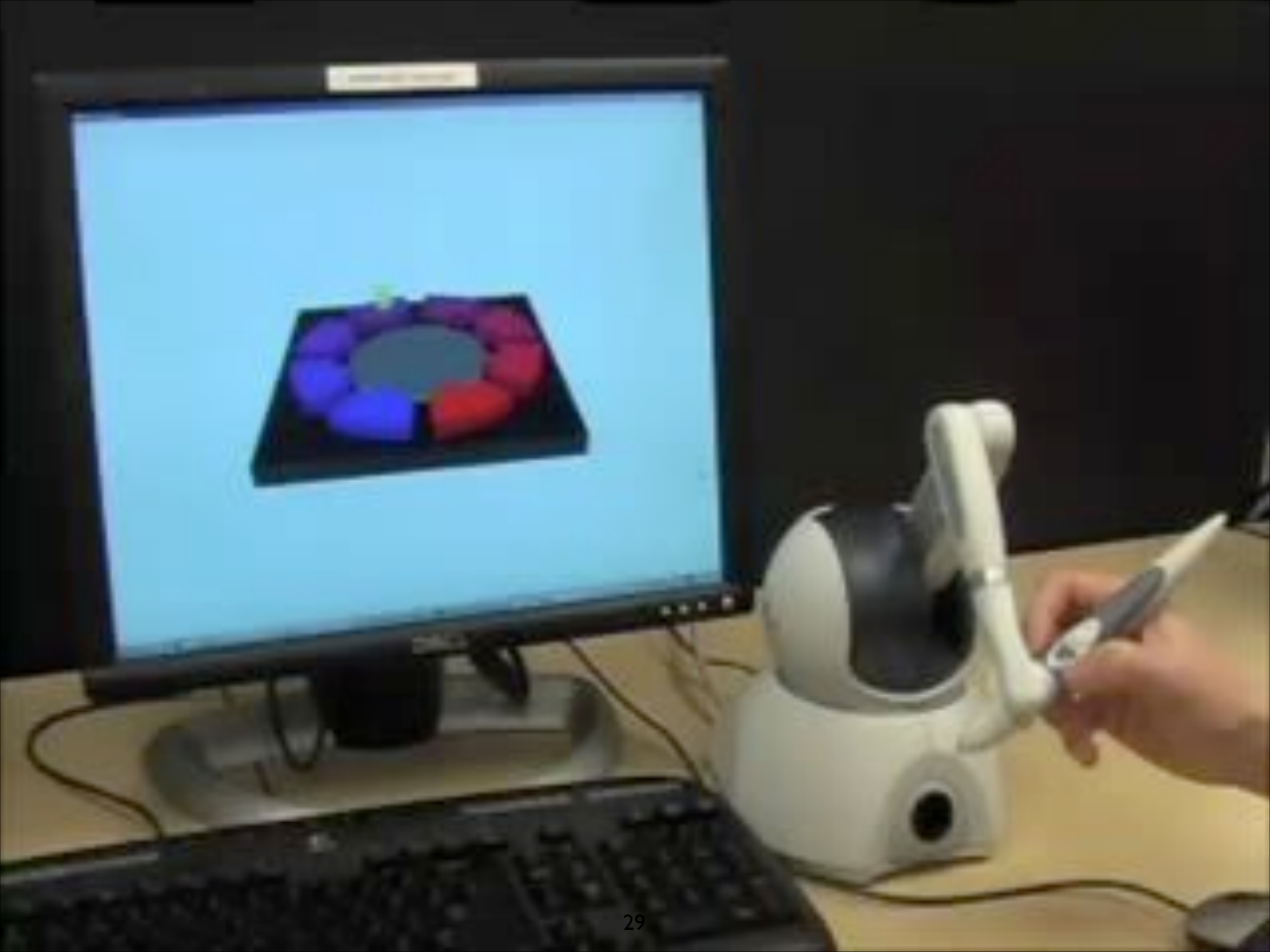



Real-time dynamic simulation of tool-texture contacts is computationally prohibitive [Otaduy and Lin, 2008]

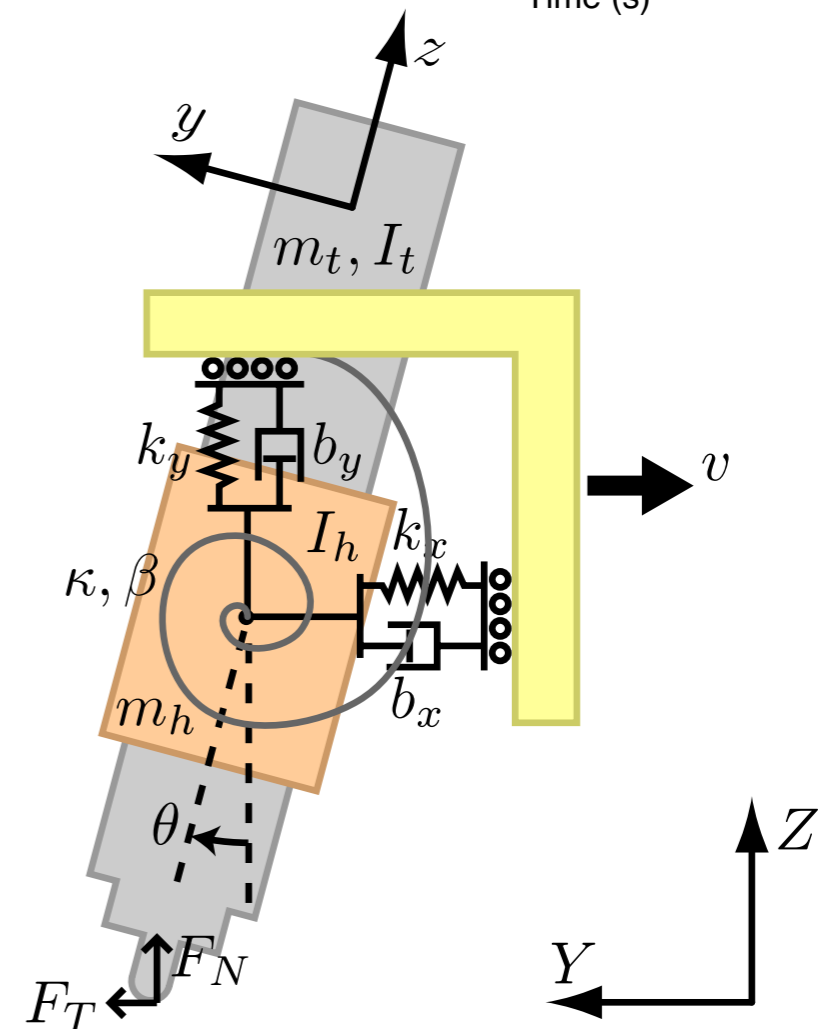
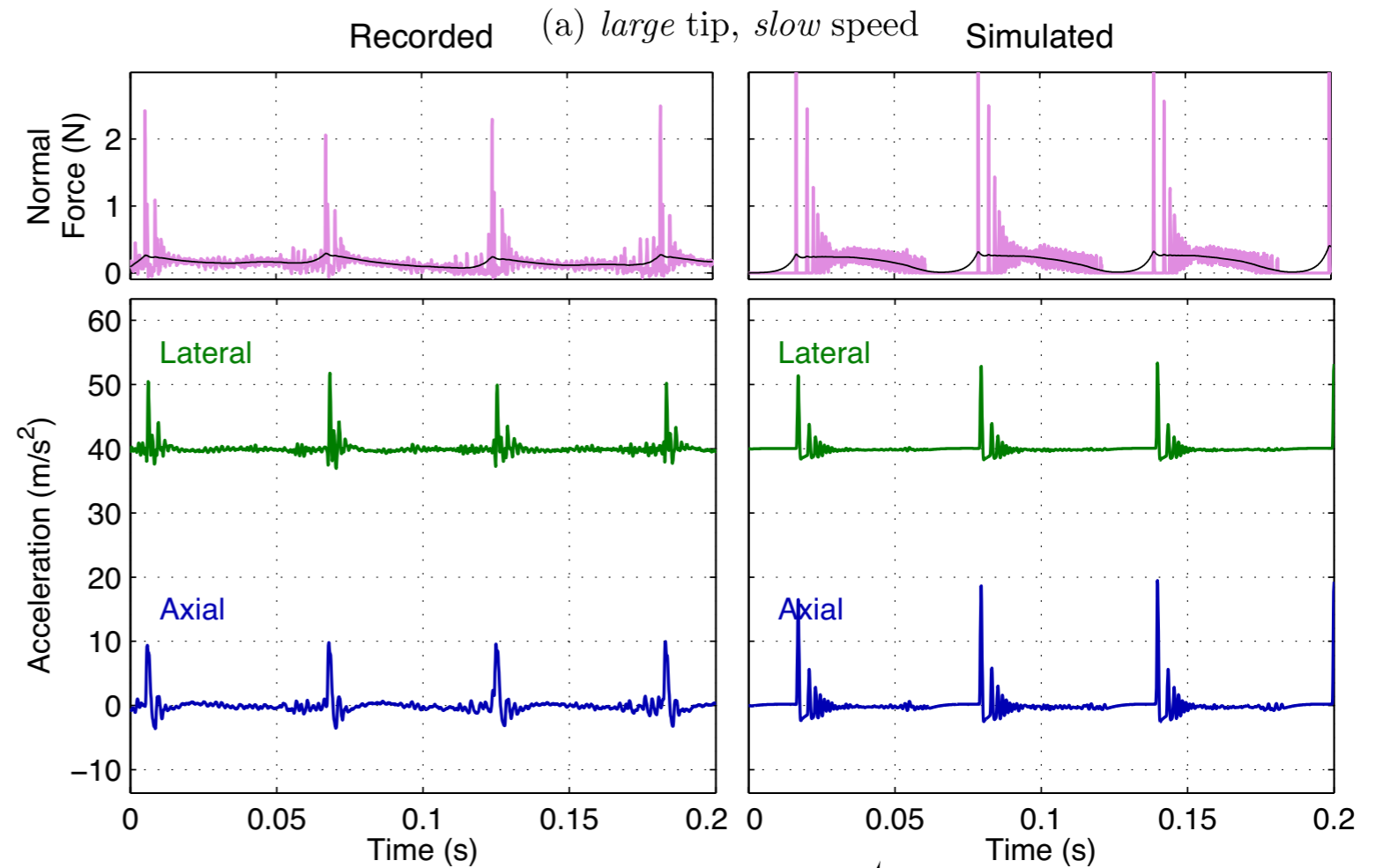

[10] Craig G. McDonald and Katherine J. Kuchenbecker. Dynamic simulation of tool-mediated texture interaction. In *Proc. IEEE World Haptics Conference*, pp. 307–312. Daejeon, South Korea, April 2013.

# Prior Approaches

- Compute 2D lateral forces from gradient of texture height field at probe location [Minsky 1995]
- Alter surface normal for force rendering based on gradient of texture offset field [Ho et al. 1999]
- Add probabilistic texture forces to standard penetration-based feedback [Siira and Pai 1996]
- Vary virtual coefficient of friction according to a probabilistic model [Pai et al. 2001]
- And many others...



# Data-Driven Modeling

# 21

## Measurement-Based Modeling for Haptic Rendering

A. M. Okamura, K. J. Kuchenbecker,  
and M. Mahvash

Measurement-based modeling is a technique for creating virtual environments based on real-world interactions. For the purpose of haptic rendering, measurement-based models are formed from data recorded during contact between an instrumented tool and a real environment. The created model can be a database of recorded responses to various haptic stimuli, an empirical input-output mapping, or a set of physics-based equations (Figure 21.1). In the database approach, recordings of a movement variable, such as position or force, are played back during haptic rendering, similar to audio recordings played on a stereo. Input-output models are created by fitting simple phenomenological models to the recorded data and tuning the haptic response as needed to provide the desired feel. Physics-based models are constructed from a fundamental understanding of the mechanical principles underlying the recorded haptic interaction; numerical values for the model's physical parameters can be selected either by fitting the model's response to the recorded data or by derivation from basic material properties. Prior work has used all three of these methods in various forms to create virtual environments that feel significantly more realistic than models that are designed and tuned without incorporation of real-world

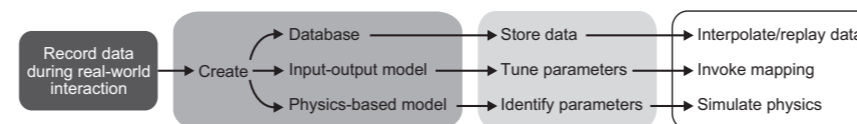

**Figure 21.1.** The process of measurement-based modeling. Approaches include database development, input-output modeling, and physics-based modeling.

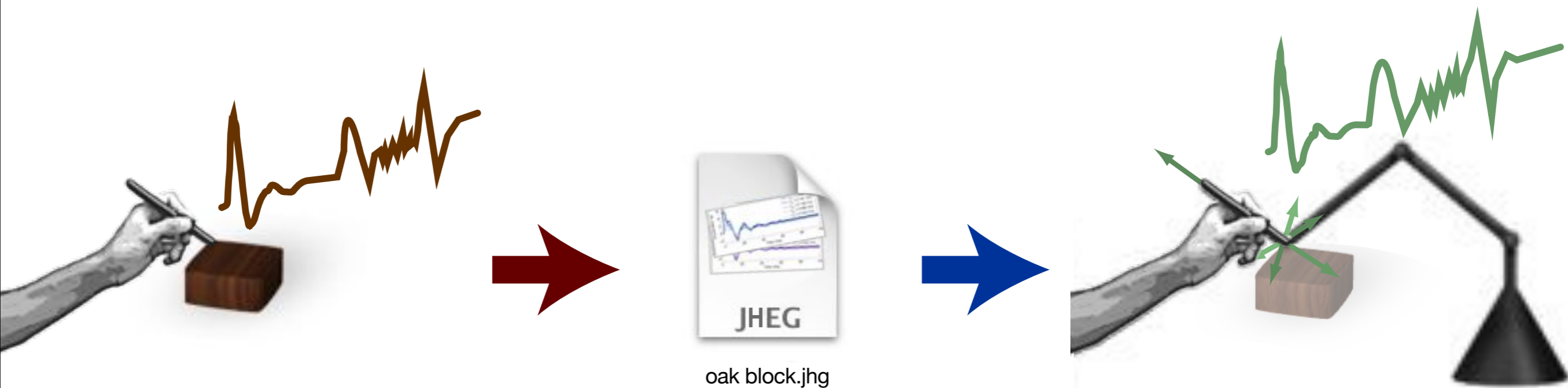

Capturing the Feel  
of a Real Surface with  
a Sensorized Tool

## Haptograph

Recreating the Feel  
of the Real Surface with  
an Active Stylus



NSF #IIS-0845670: “CAREER: Haptography: Capturing  
and Recreating the Rich Feel of Real Surfaces”

[2] Katherine J. Kuchenbecker, Joseph M. Romano, and William McMahan. Haptography: Capturing and recreating the rich feel of real surfaces. In Cedric Pradalier, Roland Siegwart, and Gerhard Hirzinger, editors, Robotics Research: the 14th International Symposium (ISRR 2009), volume 70 of Springer Tracts in Advanced Robotics, pp. 245–260. Springer, 2011.



Tool with Accelerometer

# Sample Data

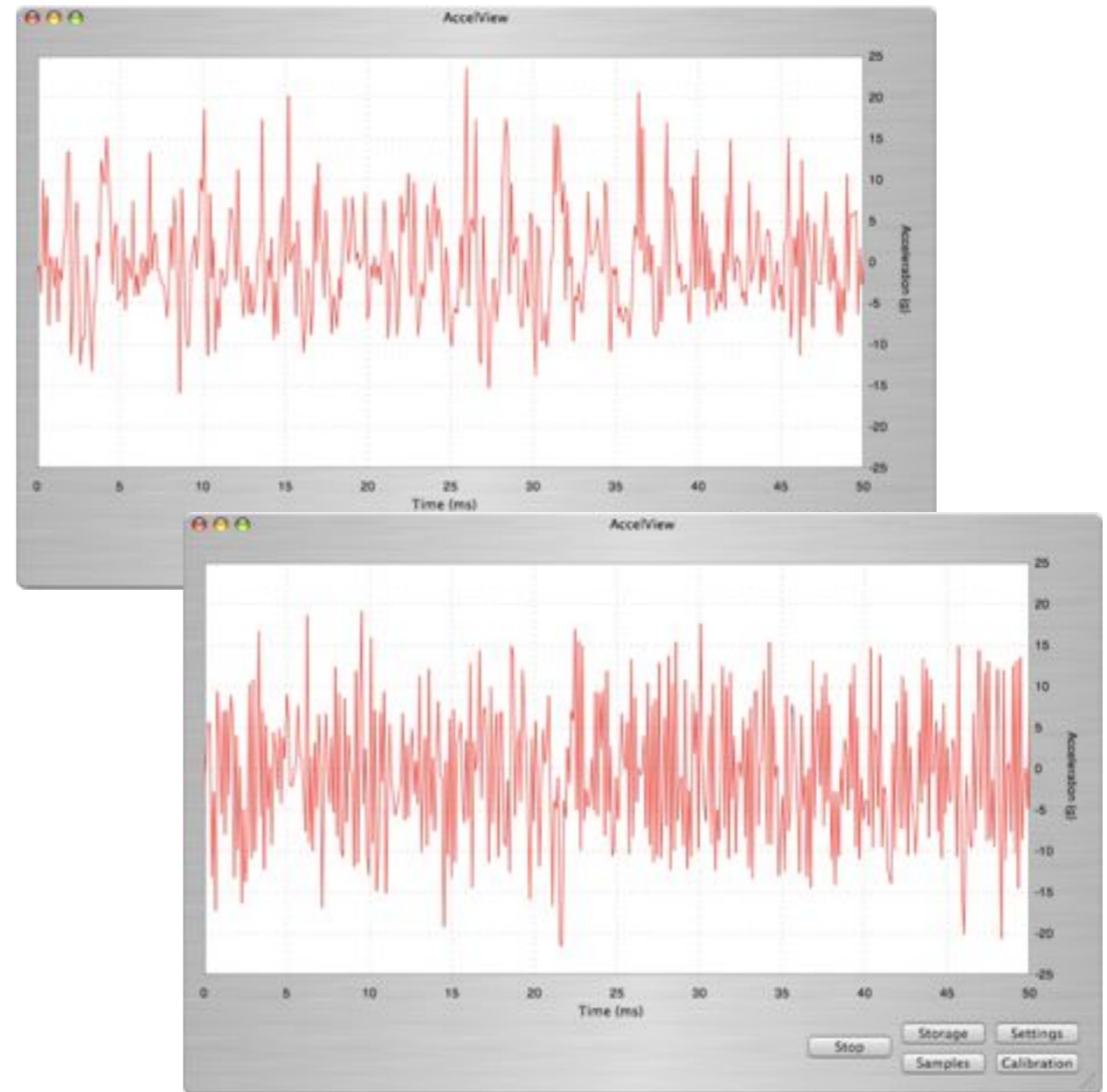
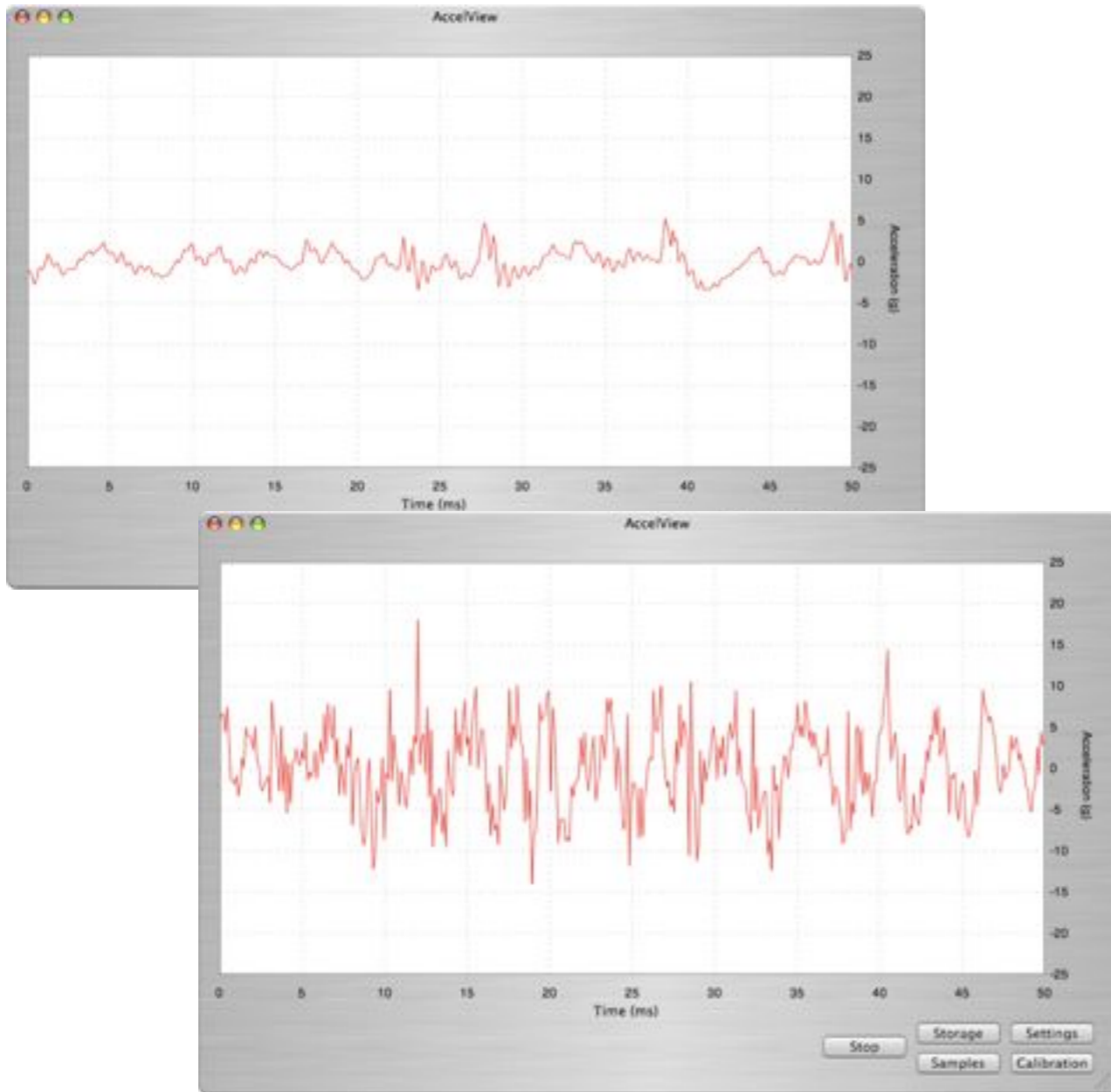
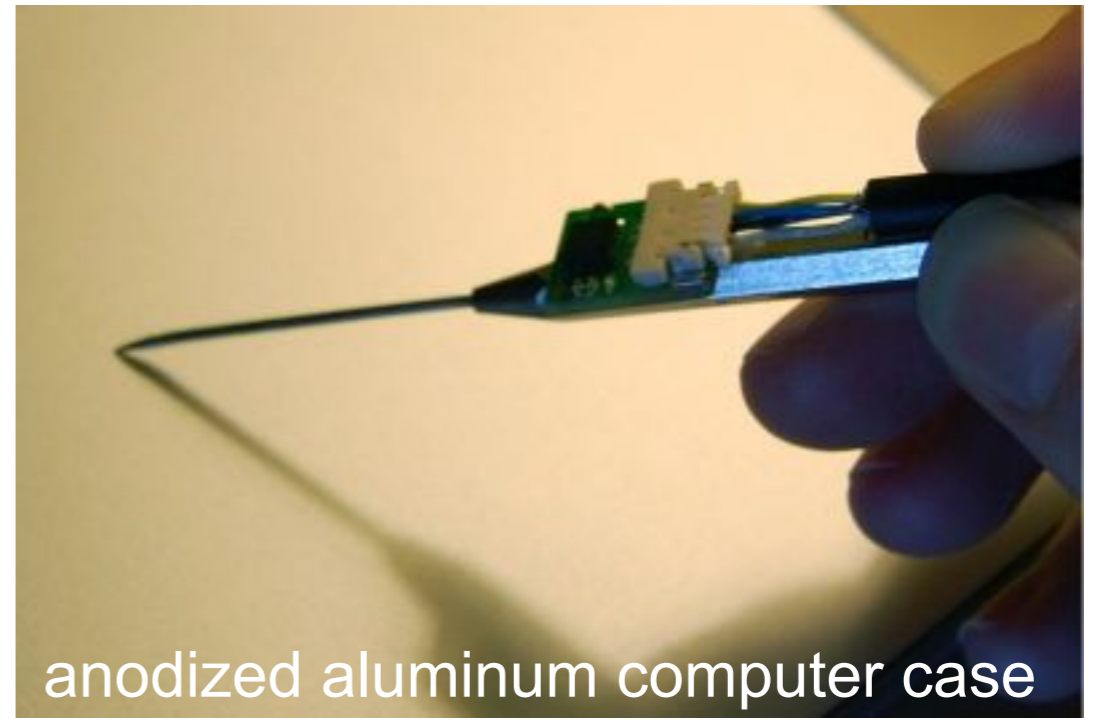
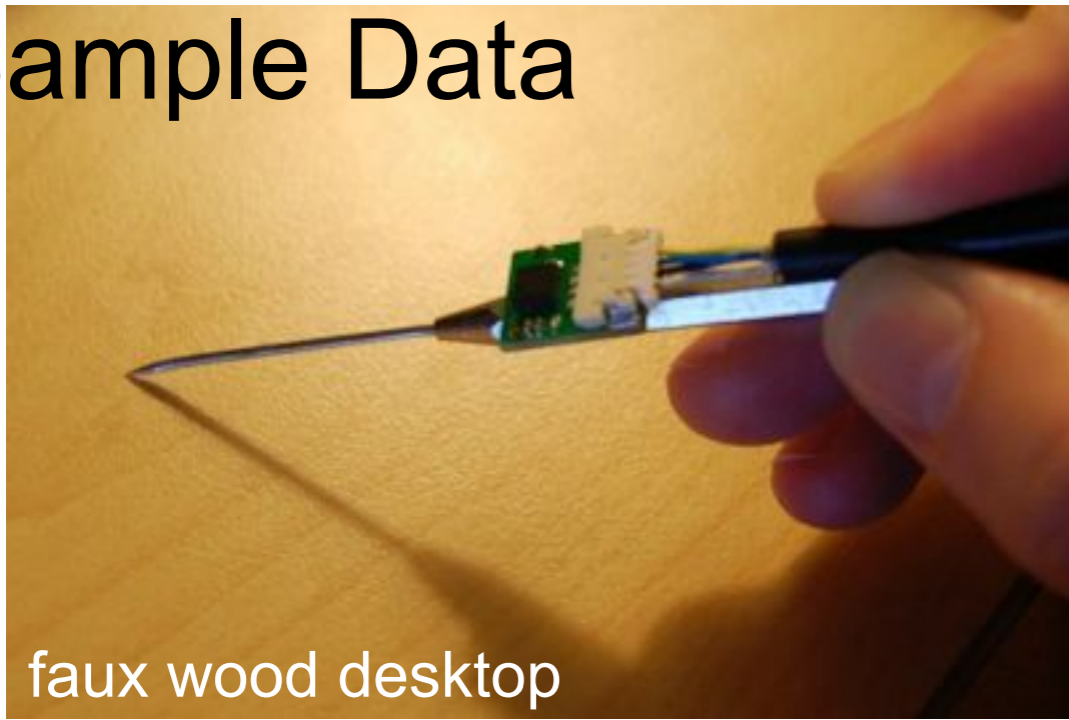





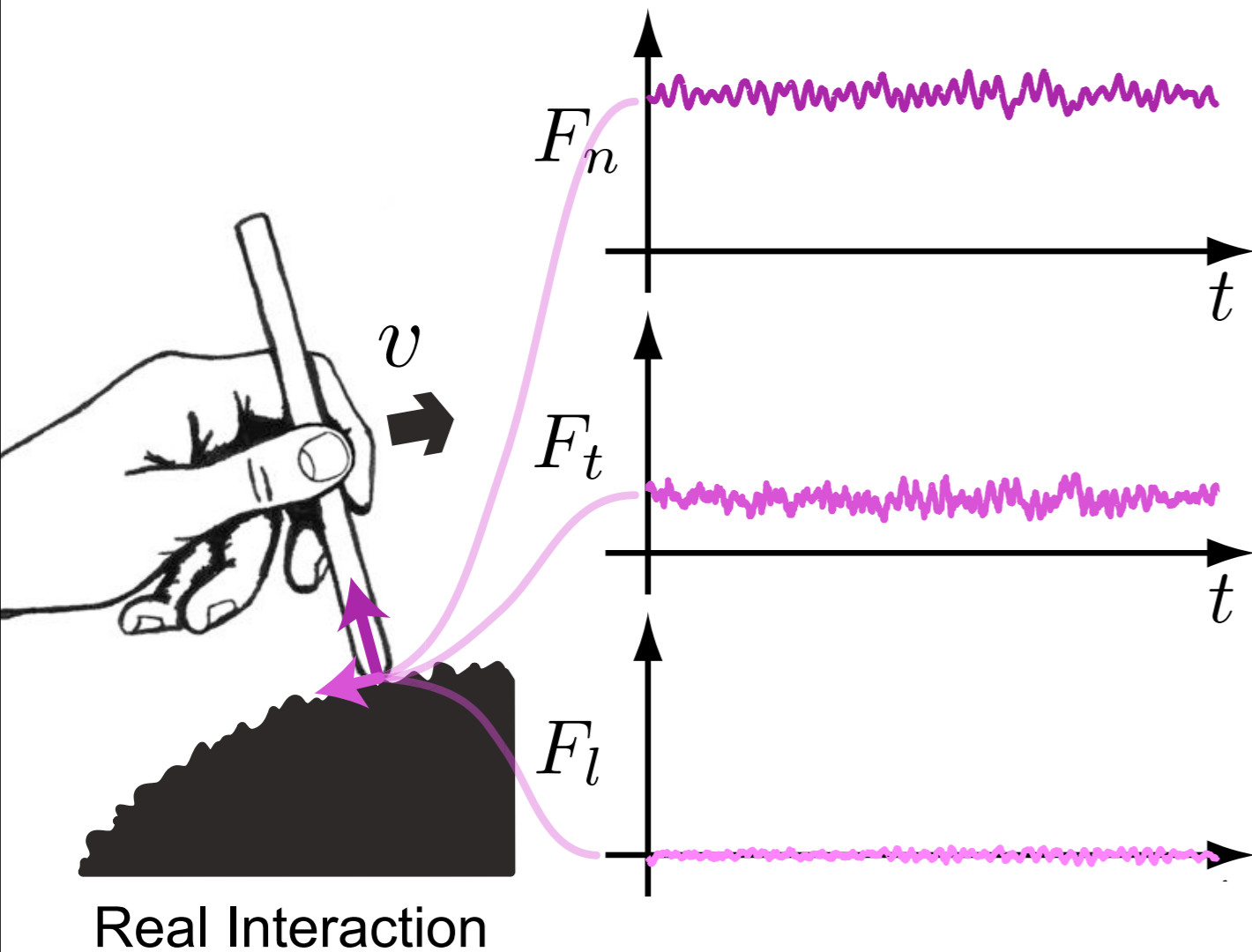

How to record  
and model  
texture  
interactions?

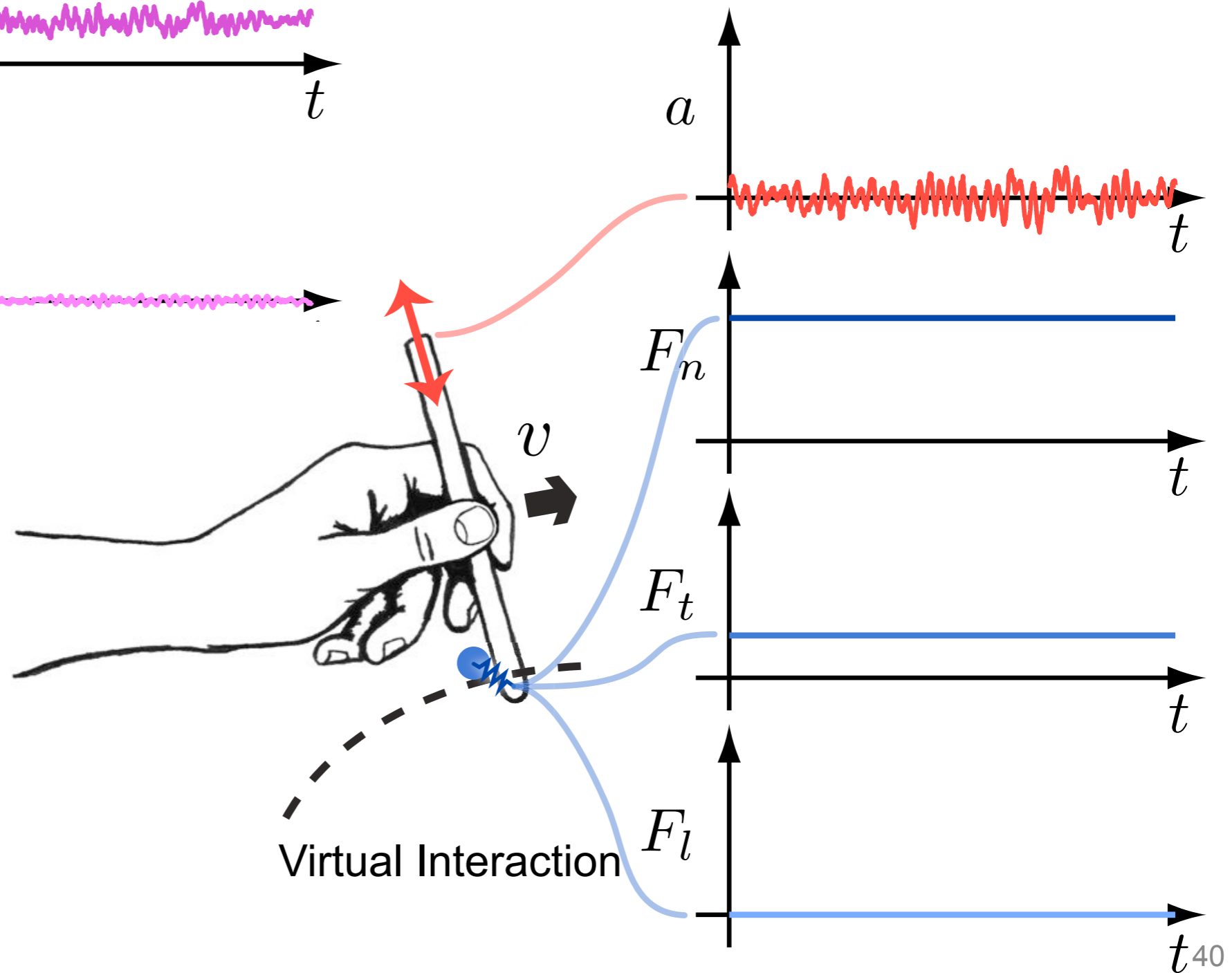



# Activity 2

- Find your partner and your chopstick.
- **Subject:** Hold the chopstick like a pen, fat end down, in the air, and close your eyes. Pay attention to the sensations that you feel.
- **Experimenter:** Chose a texture and move it back and forth against the fat end of the chopstick. Move with low and high speed, with low and high force.
- Switch roles and pick a different texture.



# Reflections on Activity 2

- Four different ways of interacting:
  - Low scanning speed and medium normal force
  - High scanning speed and medium normal force
  - Medium scanning speed and low normal force
  - Medium scanning speed and high normal force

What did you notice during this activity?

# Recording Hardware

# Data recorded

- Three axes
  - Force
  - Position
  - Orientation
  - High-Frequency Acceleration

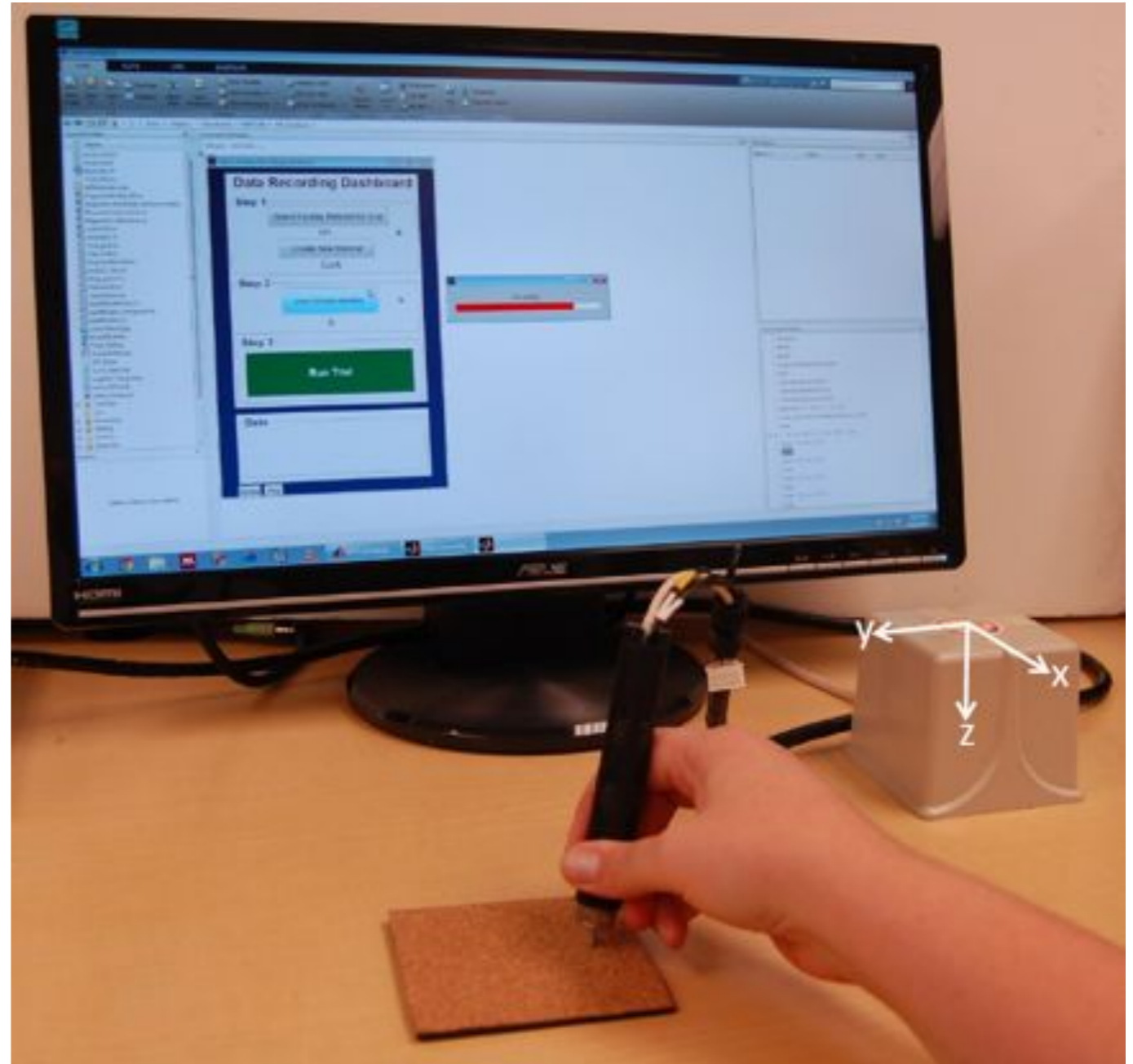

# Motivation for recording force and speed

- Power and frequency content of acceleration strongly depend on normal force and scanning speed

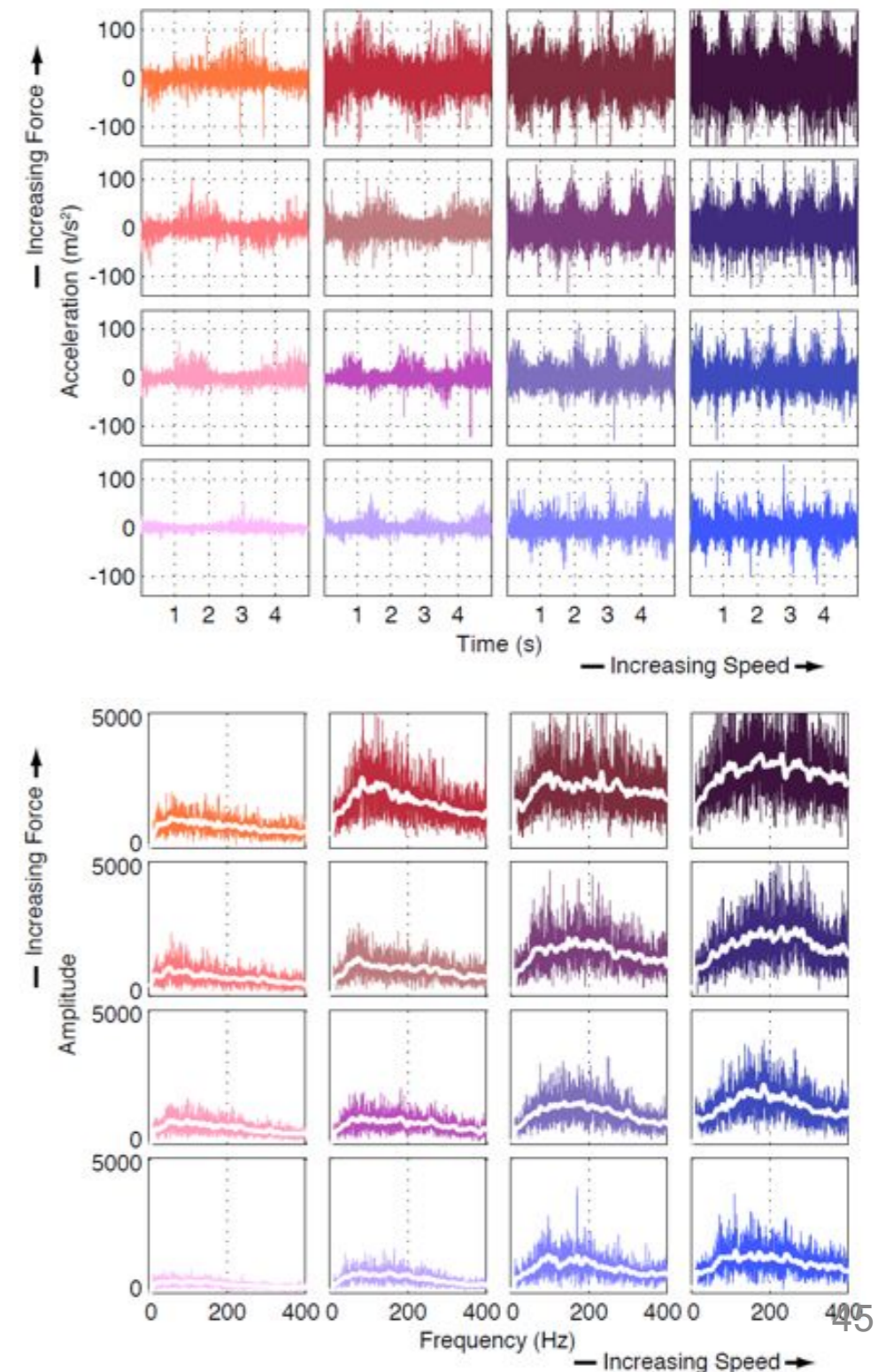

# Sensors

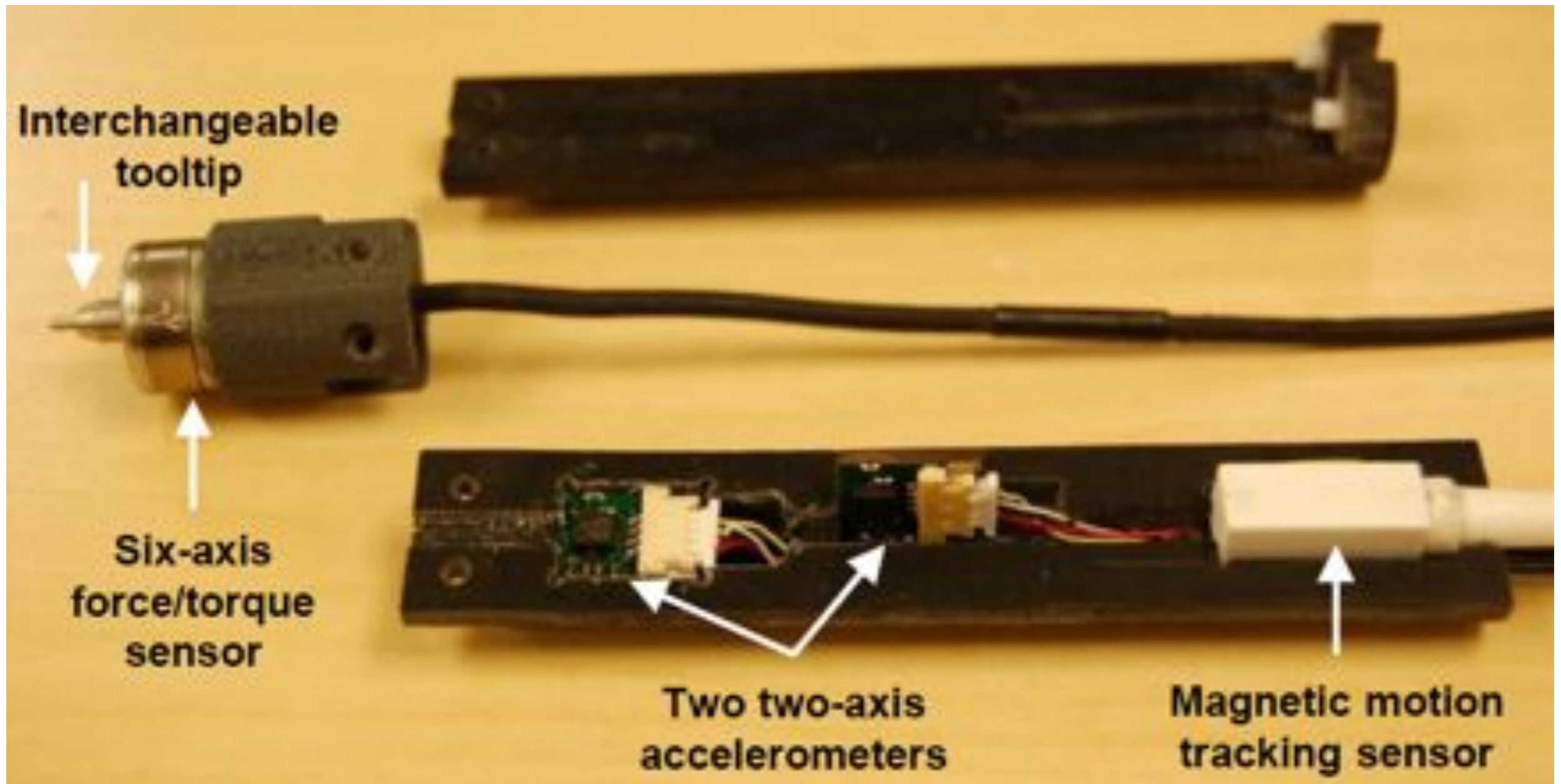

# Recording Procedure

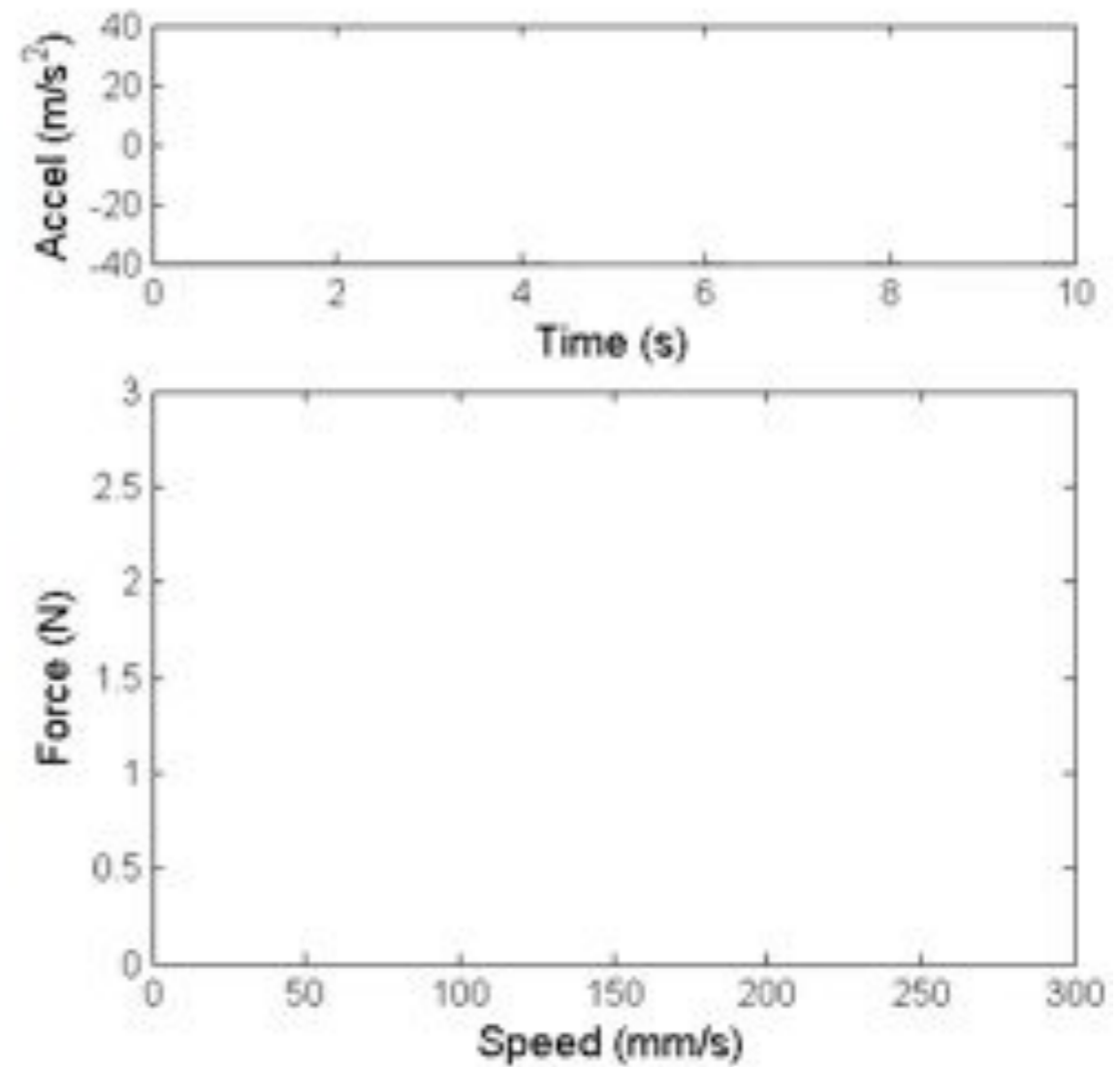

# Recording Procedure

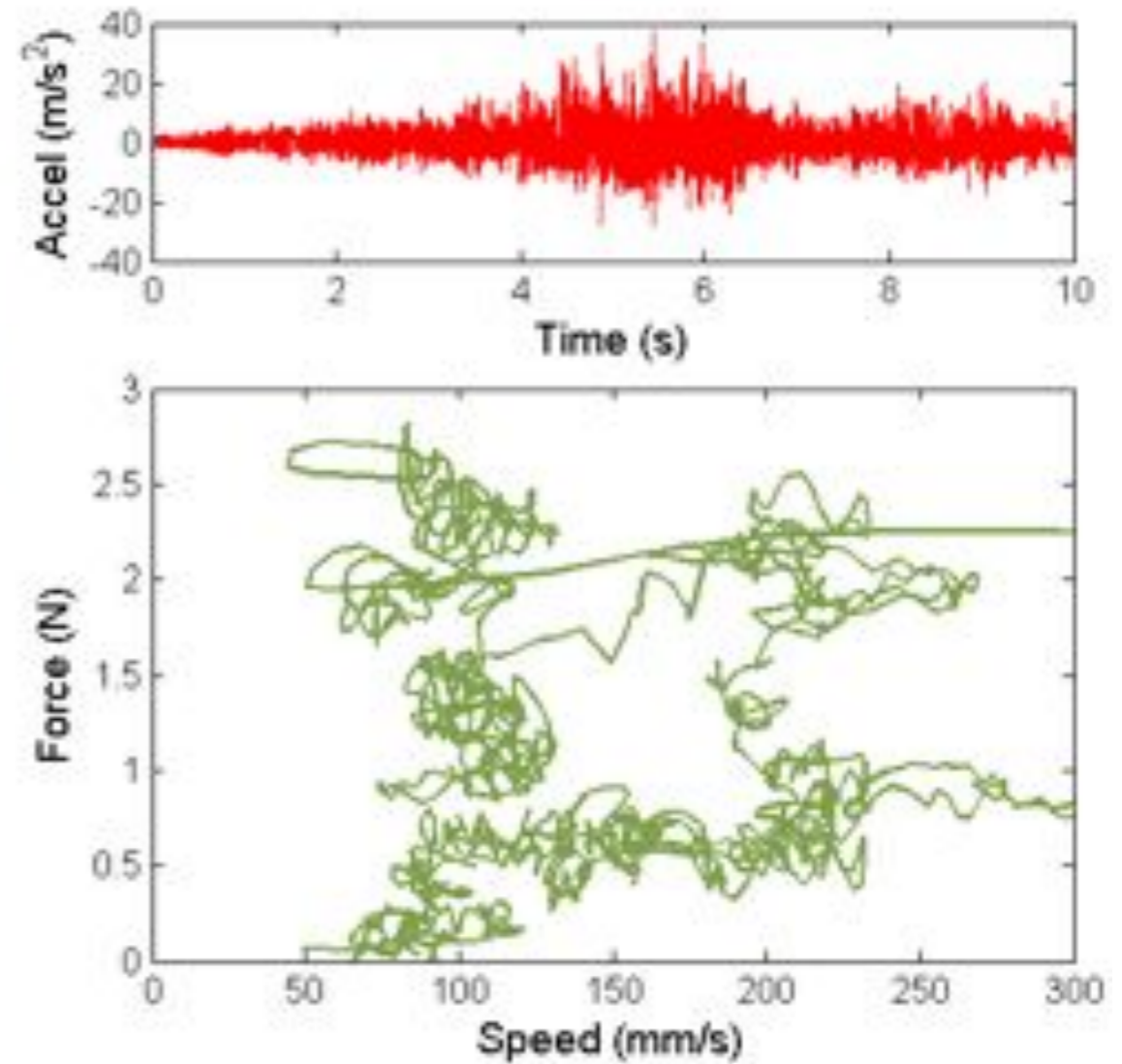



# Recorded Data

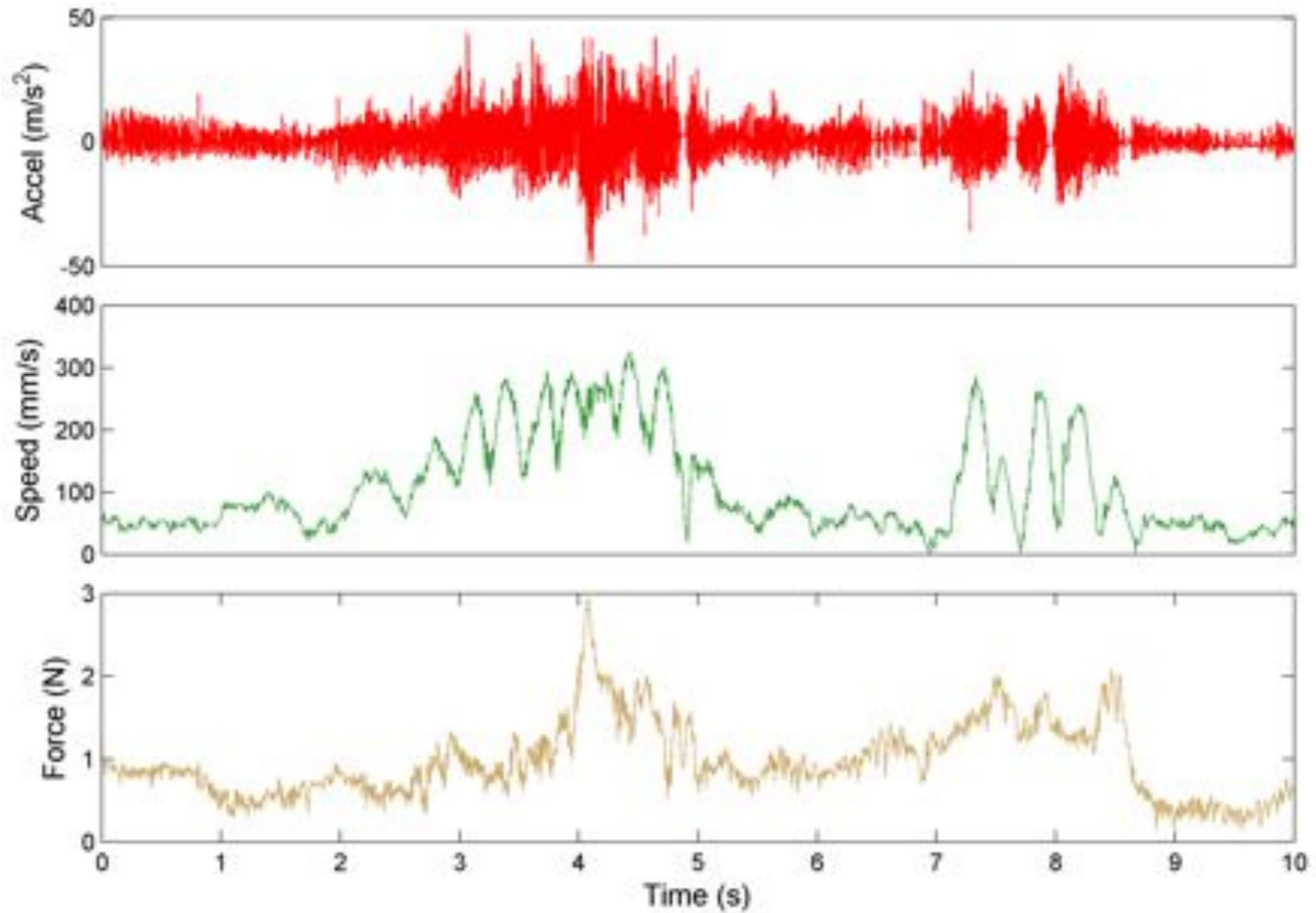

# Demonstration 1: Recording



# Demonstration 1: Recording



# Demonstration 1: Recording

Data Recorded from Canvas 1

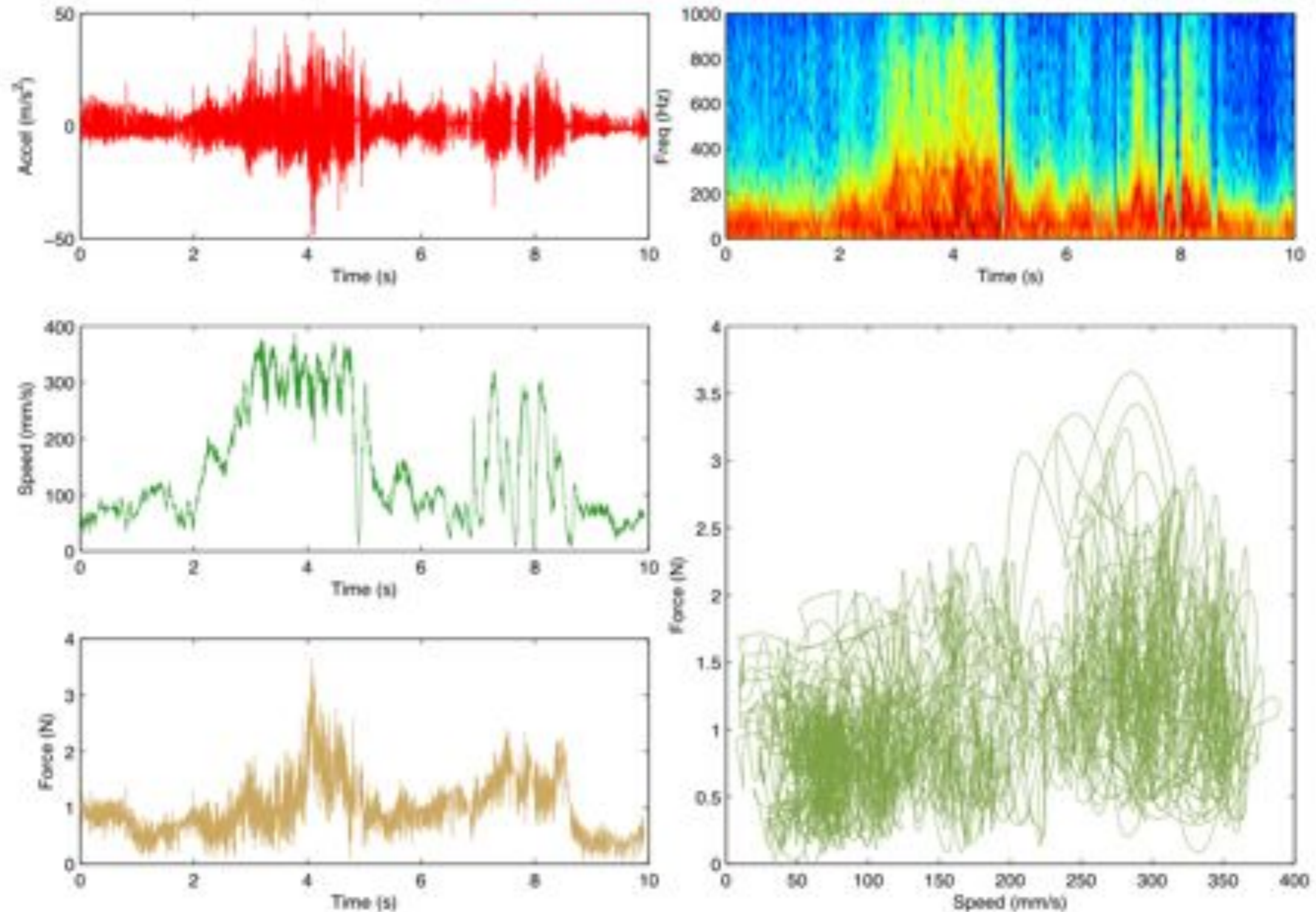

# Demonstration 1: Recording

What questions do you have?

# Coffee Break

Please be back by 3:30

Demos are available to try during the break.

# Friction Modeling

# Data Recorded from Canvas 1

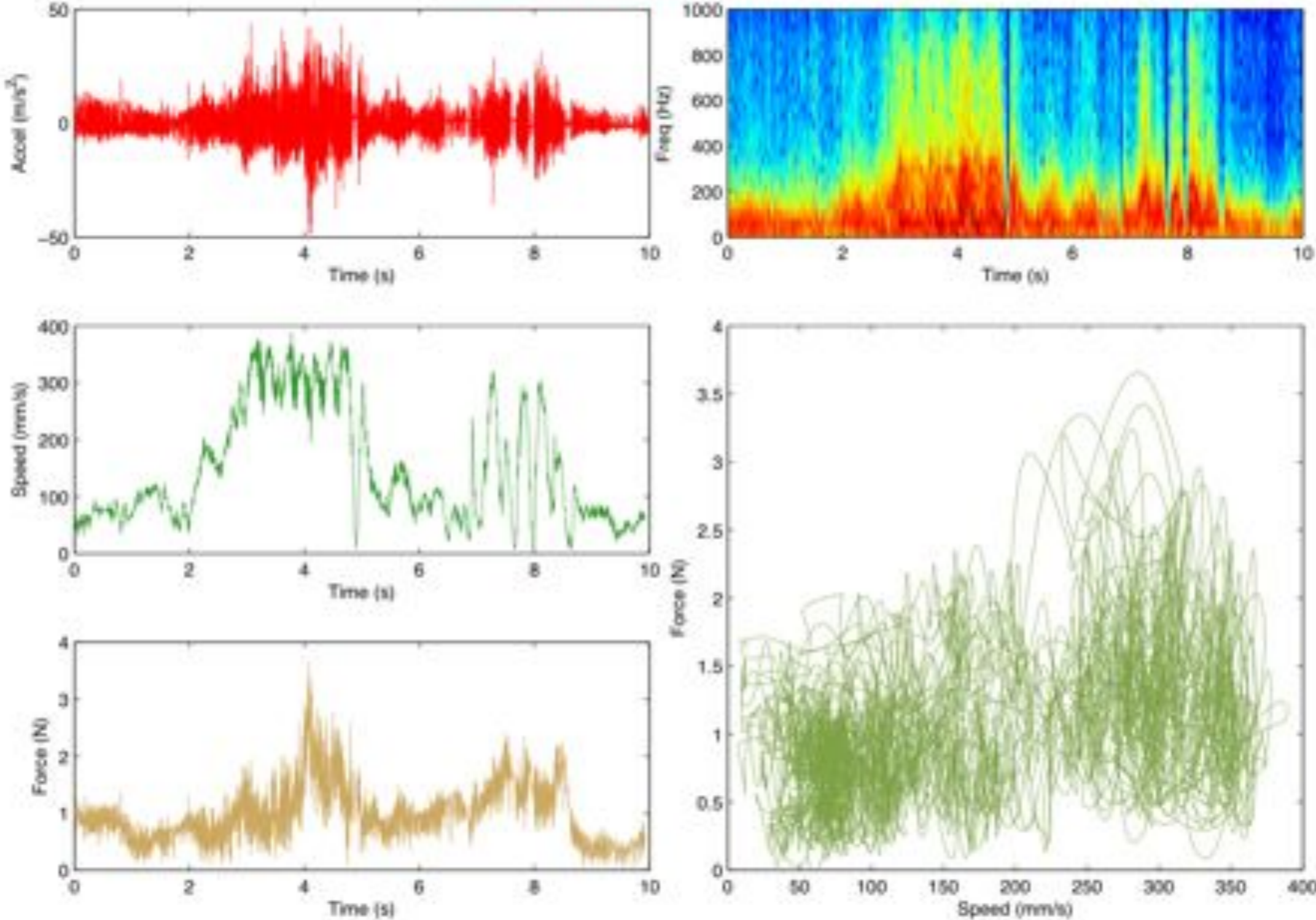



# Friction Model Selection

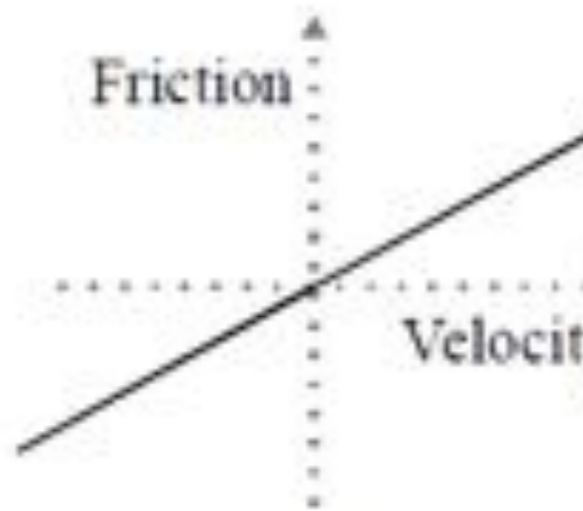

Viscous damping

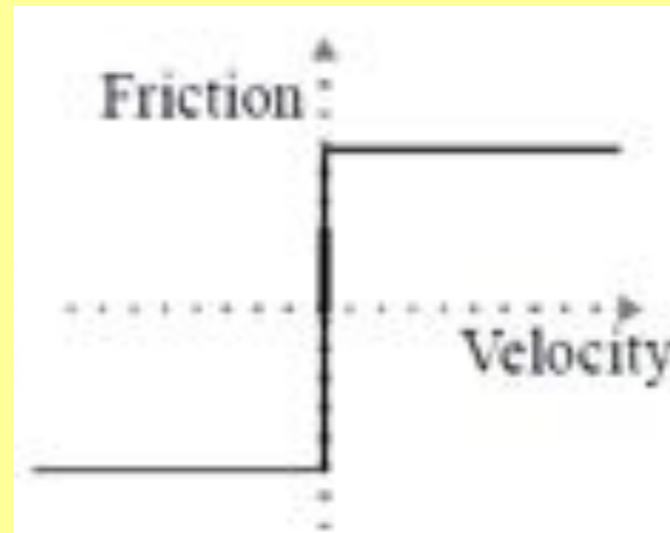

Coulomb model

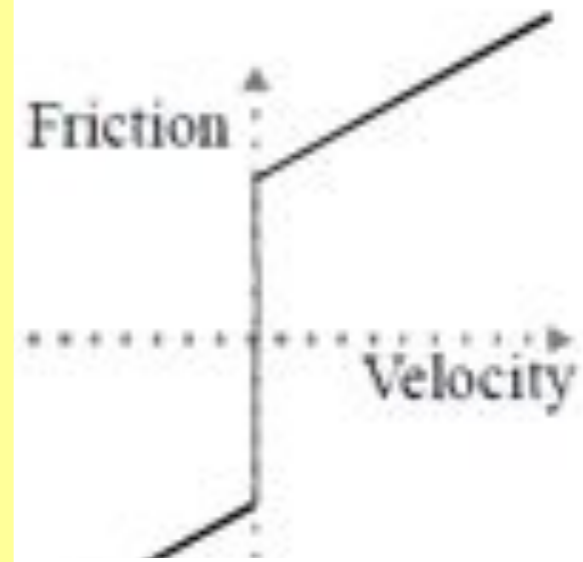

Coulomb and viscous

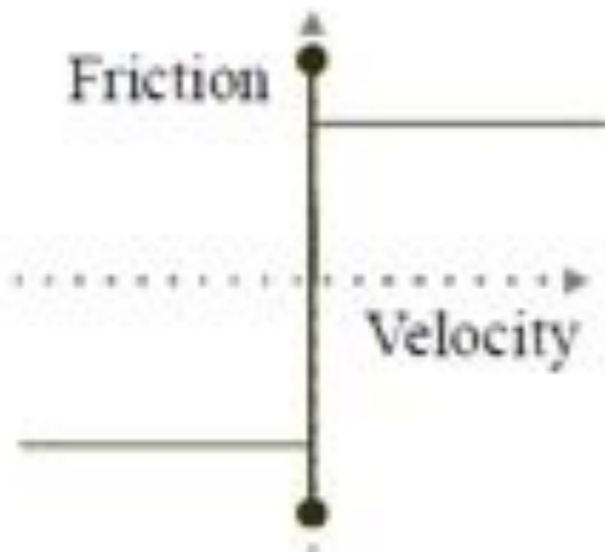

Stiction

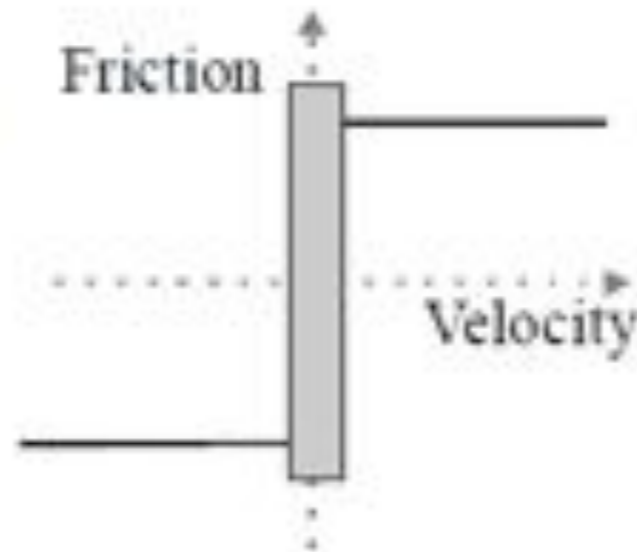

Karnopp's model

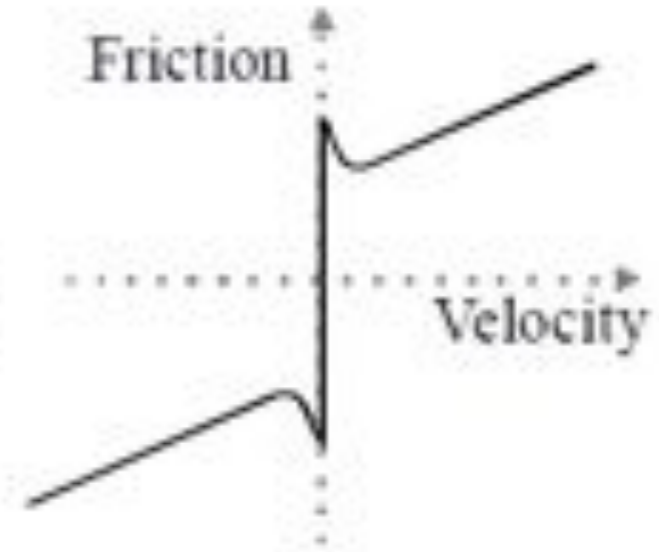

Stribeck effect

# Recording procedure

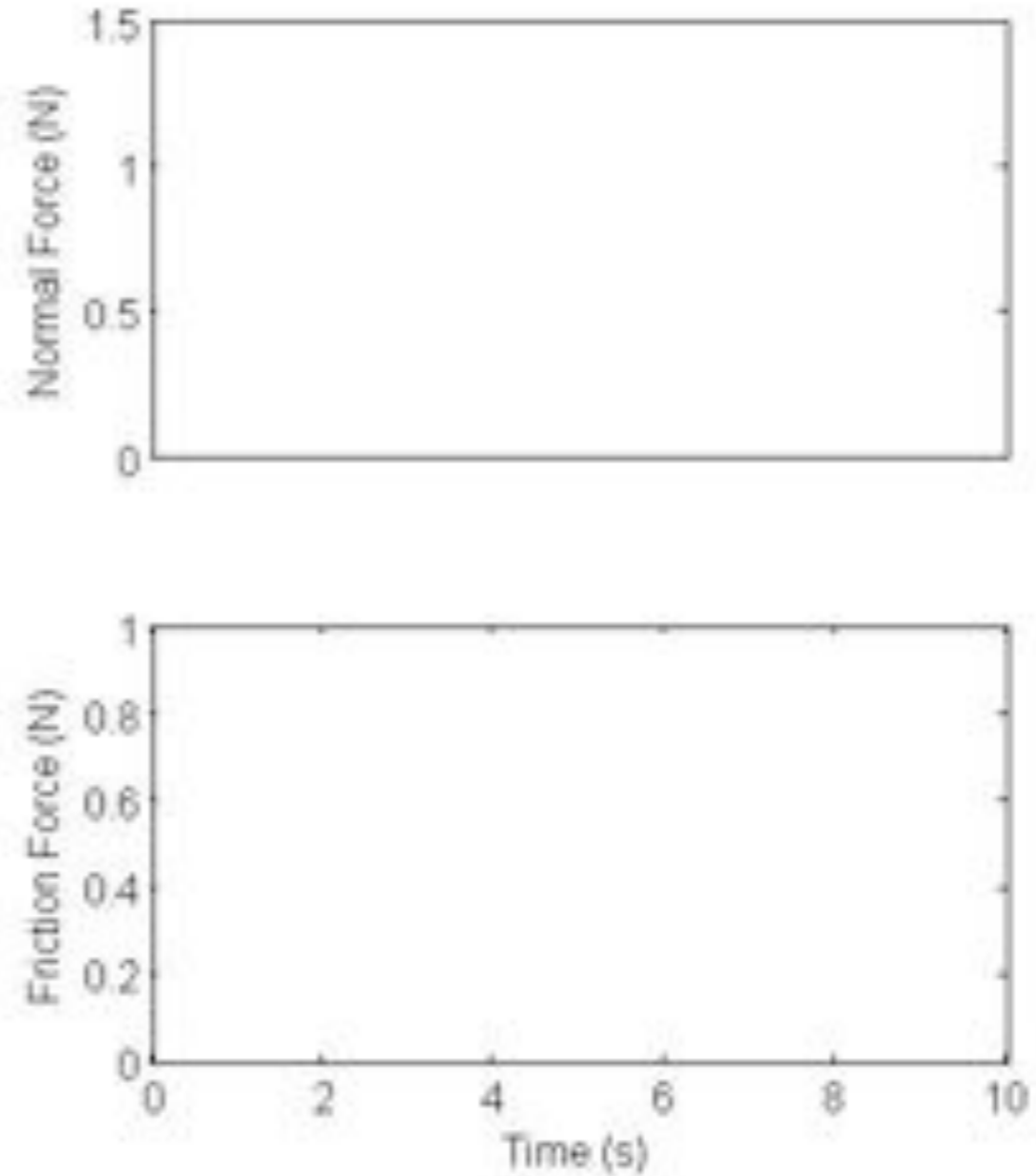
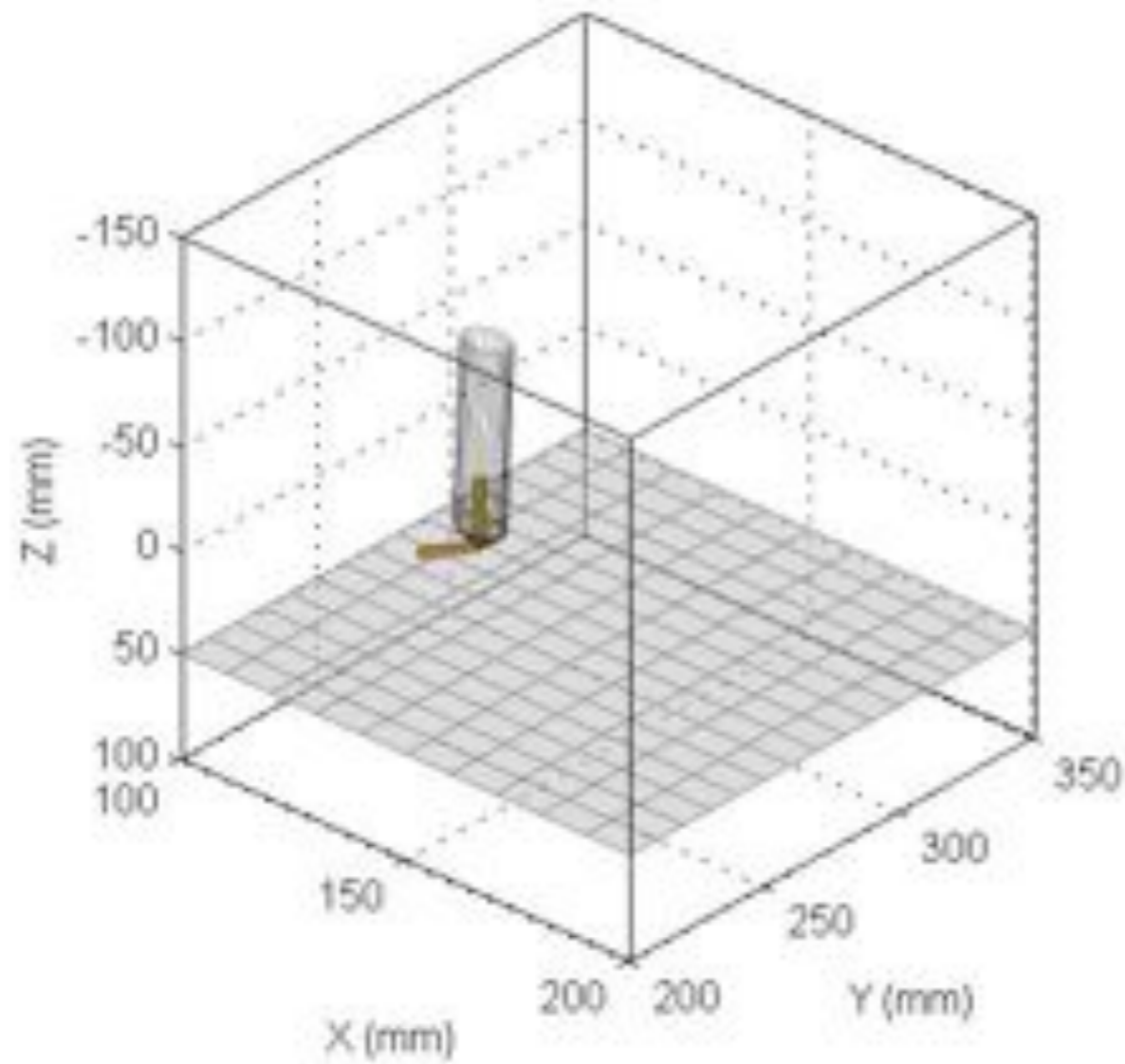

# Recording procedure

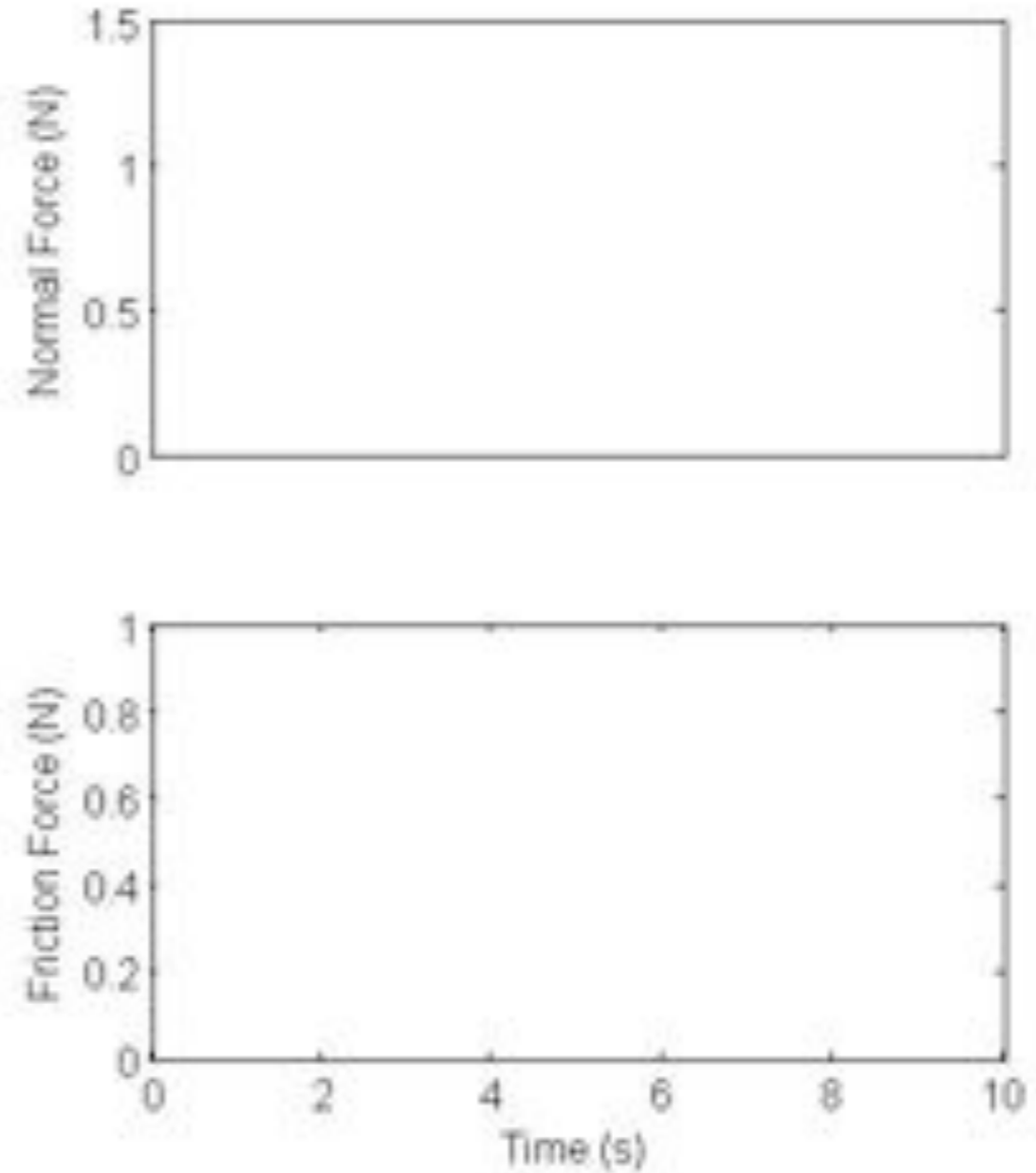
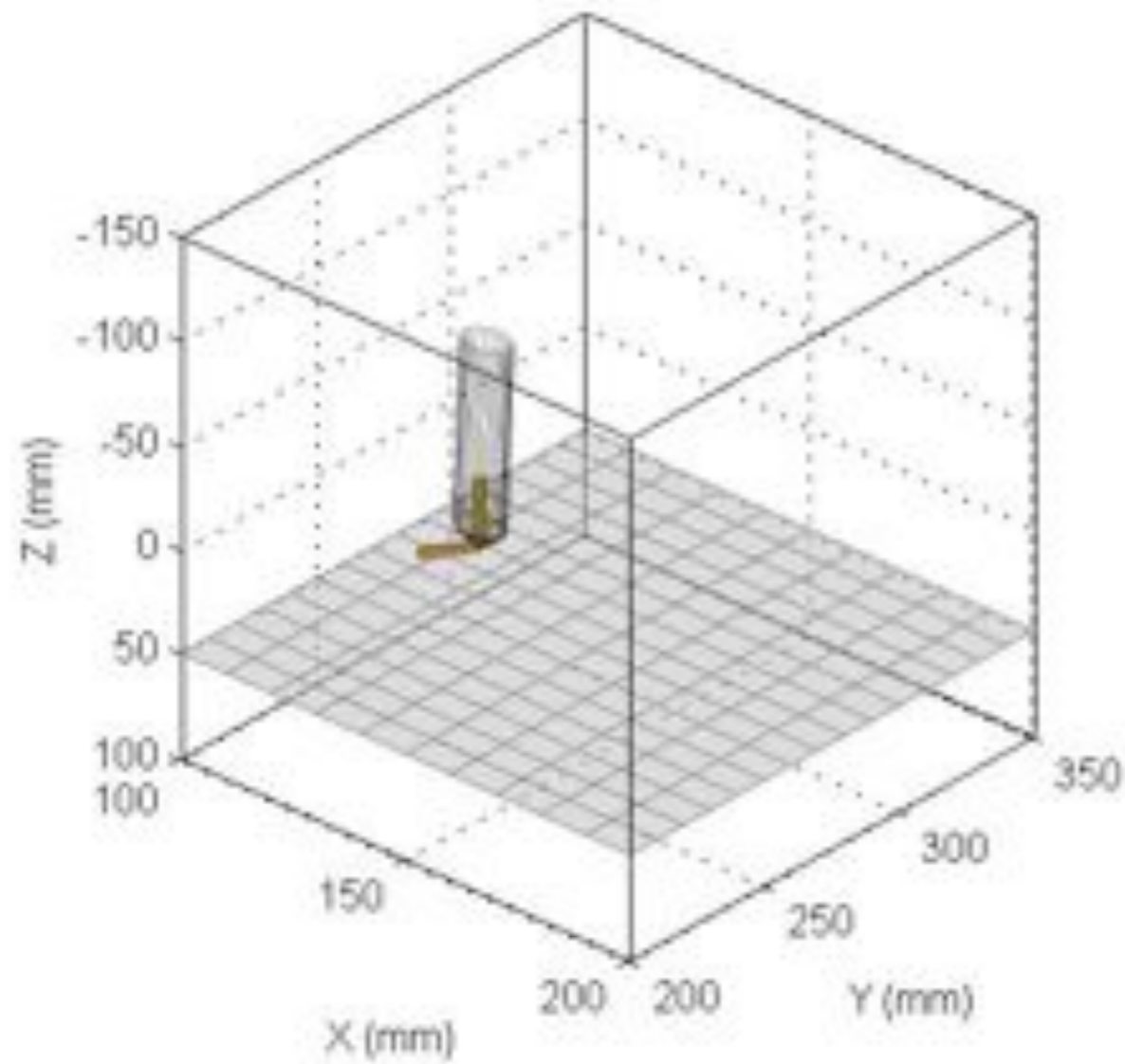

# Recording procedure

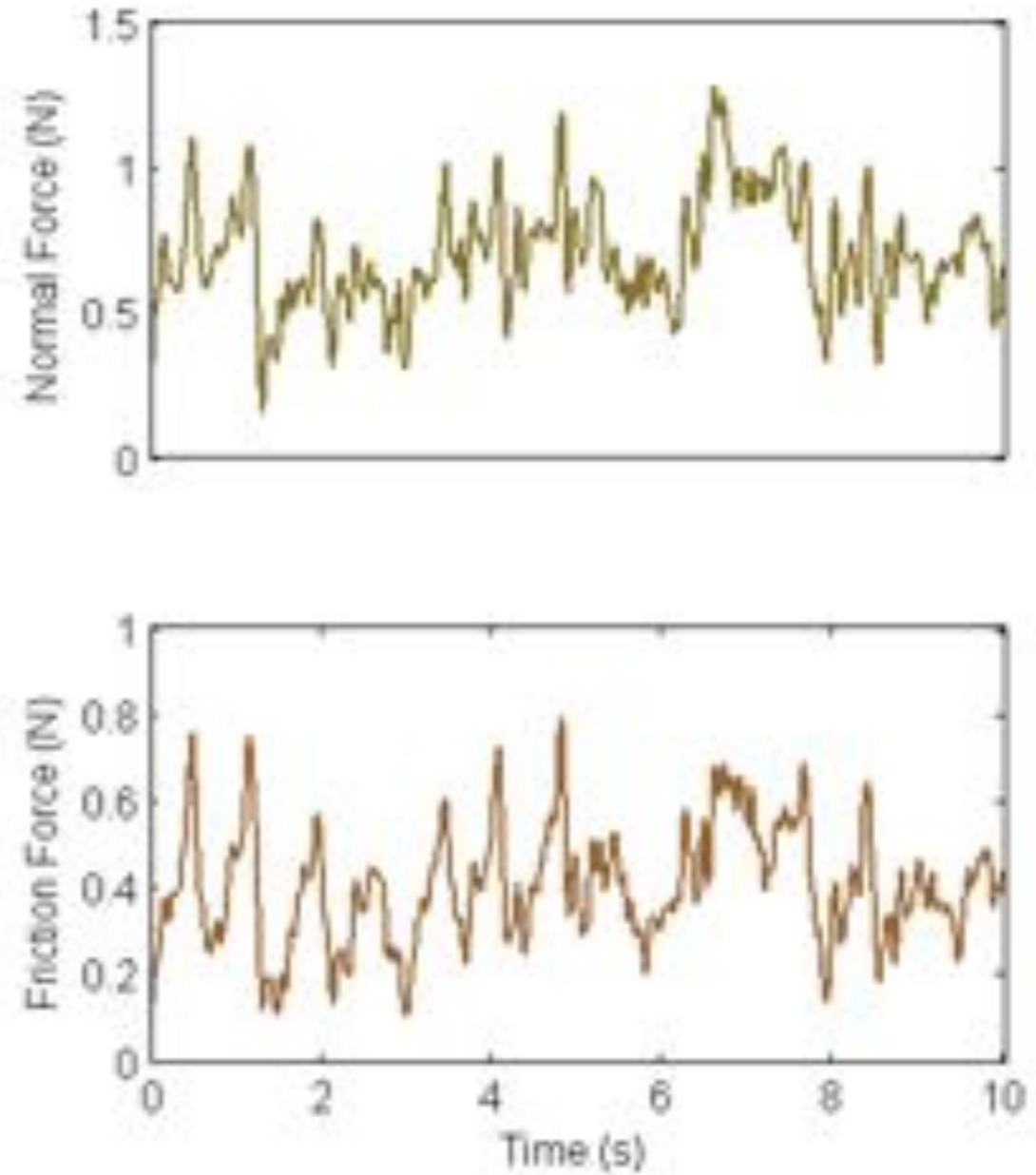
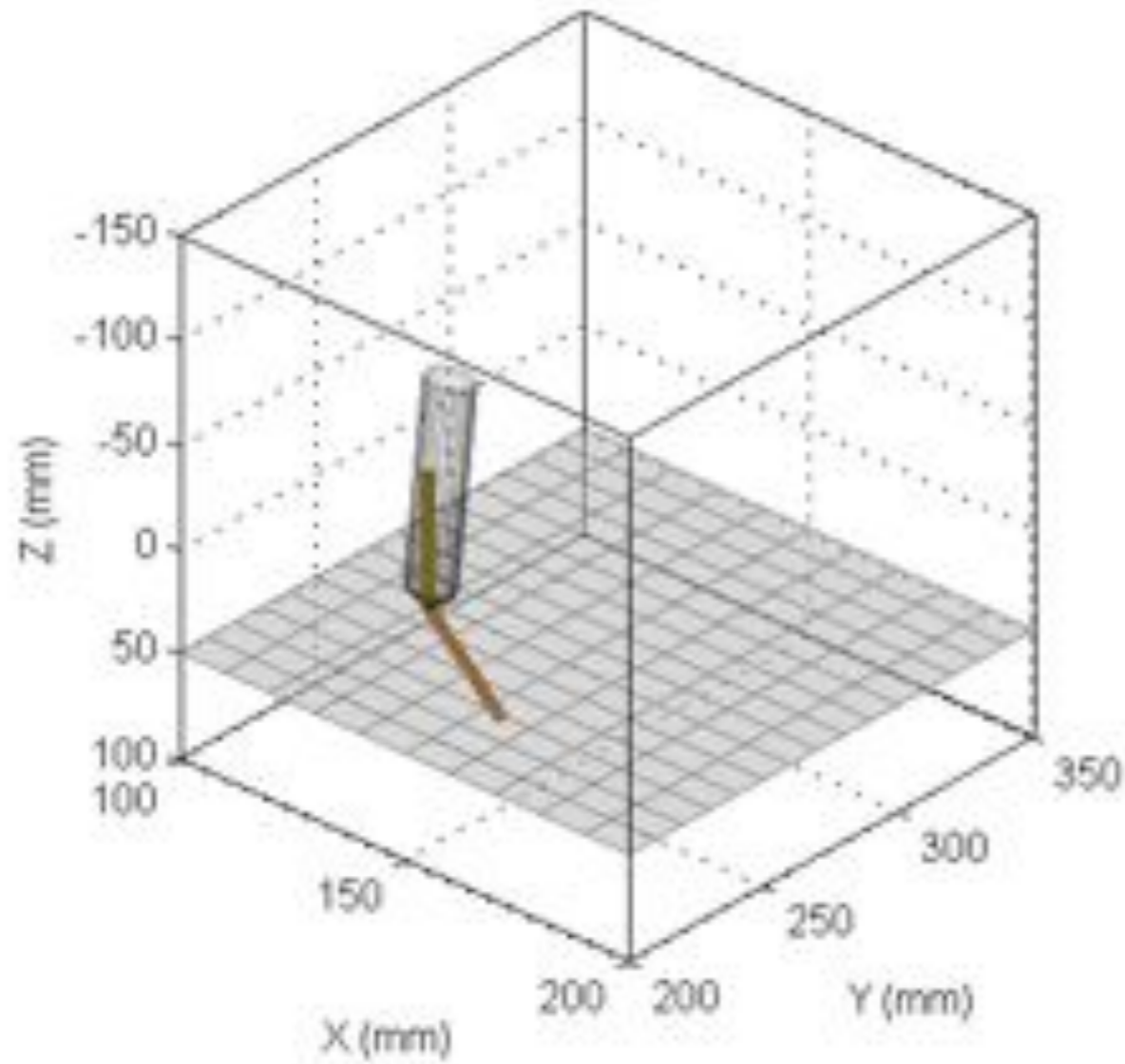

# Force data processing

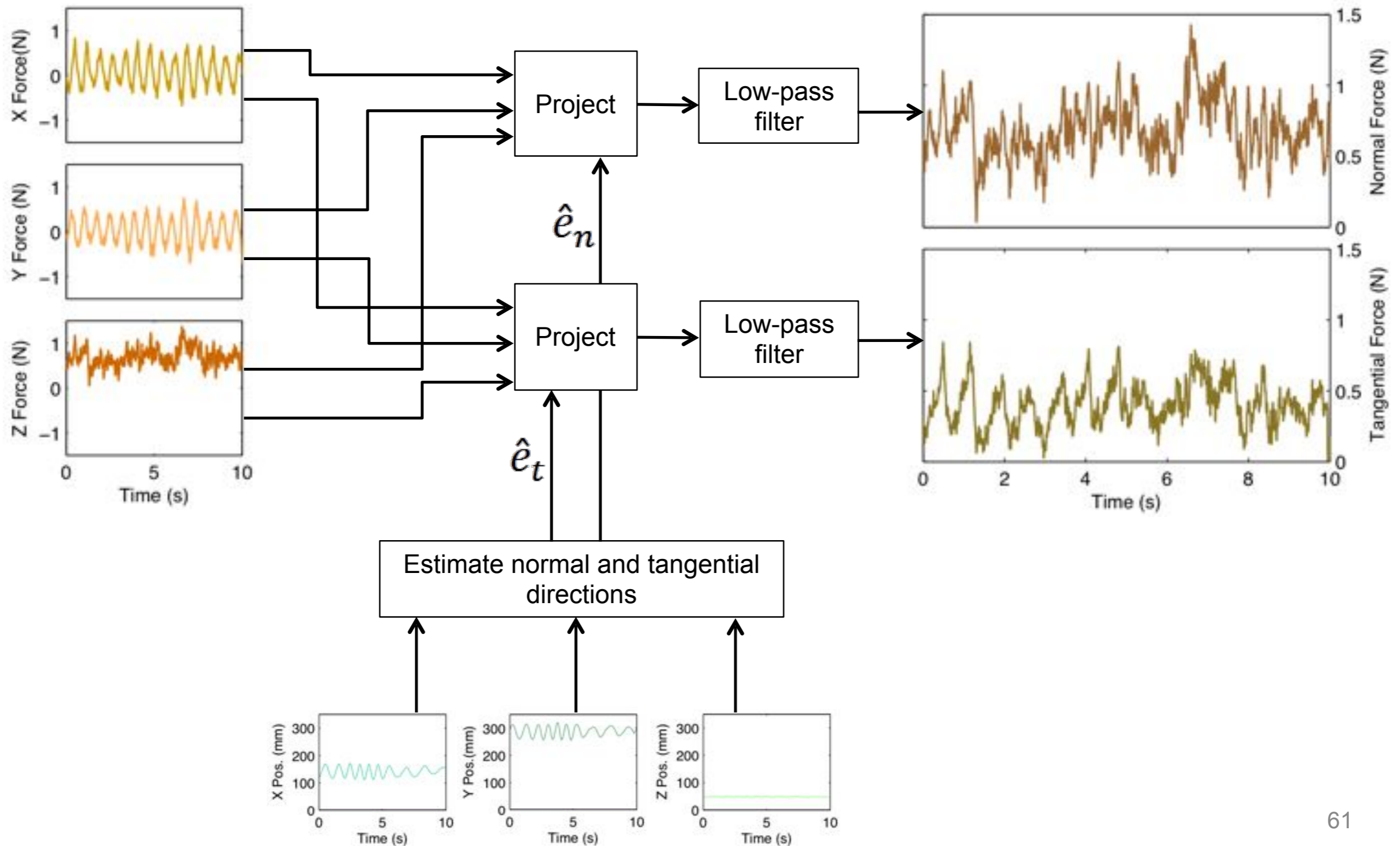

# Fitting Coulomb friction model

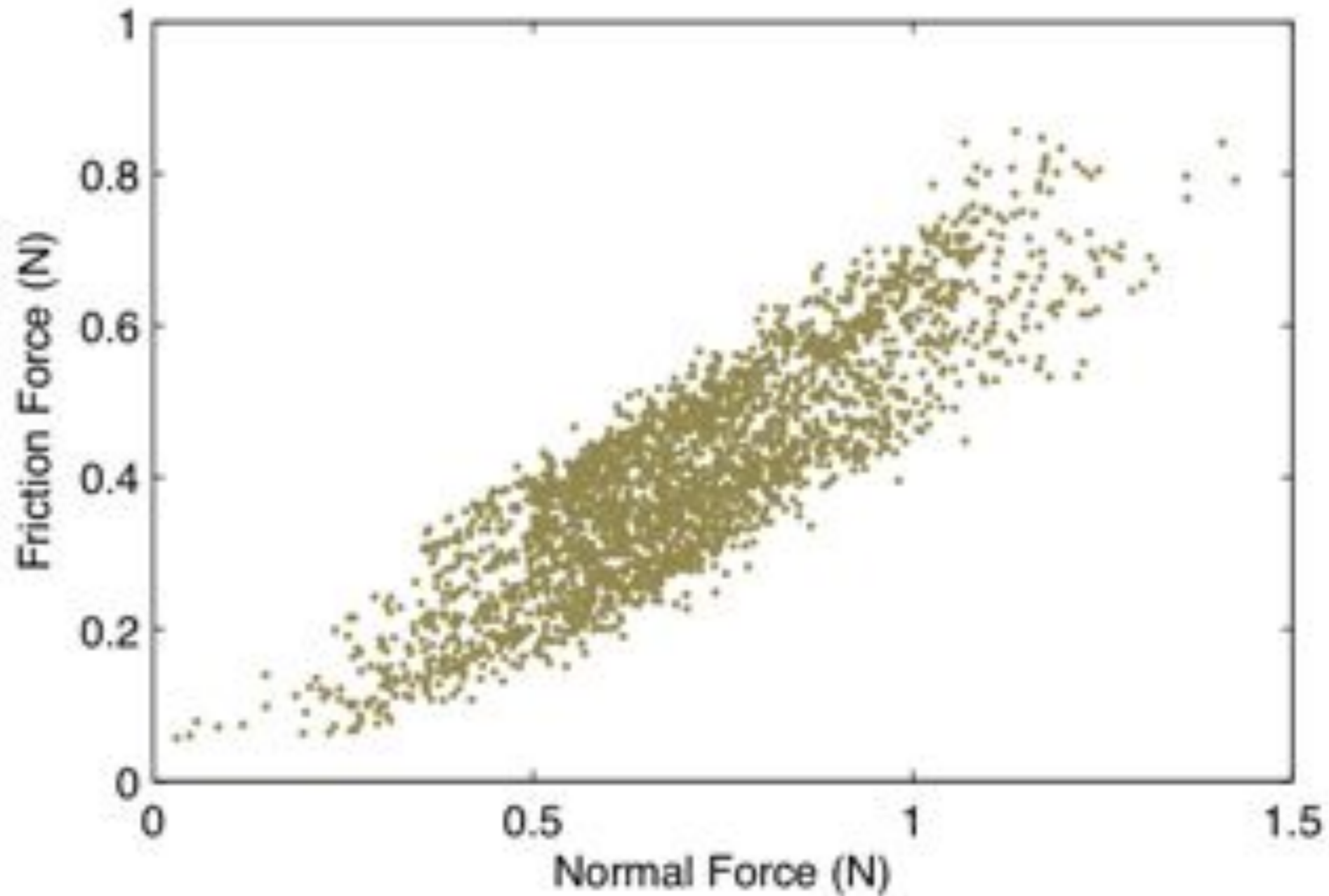

# Fitting Coulomb friction model

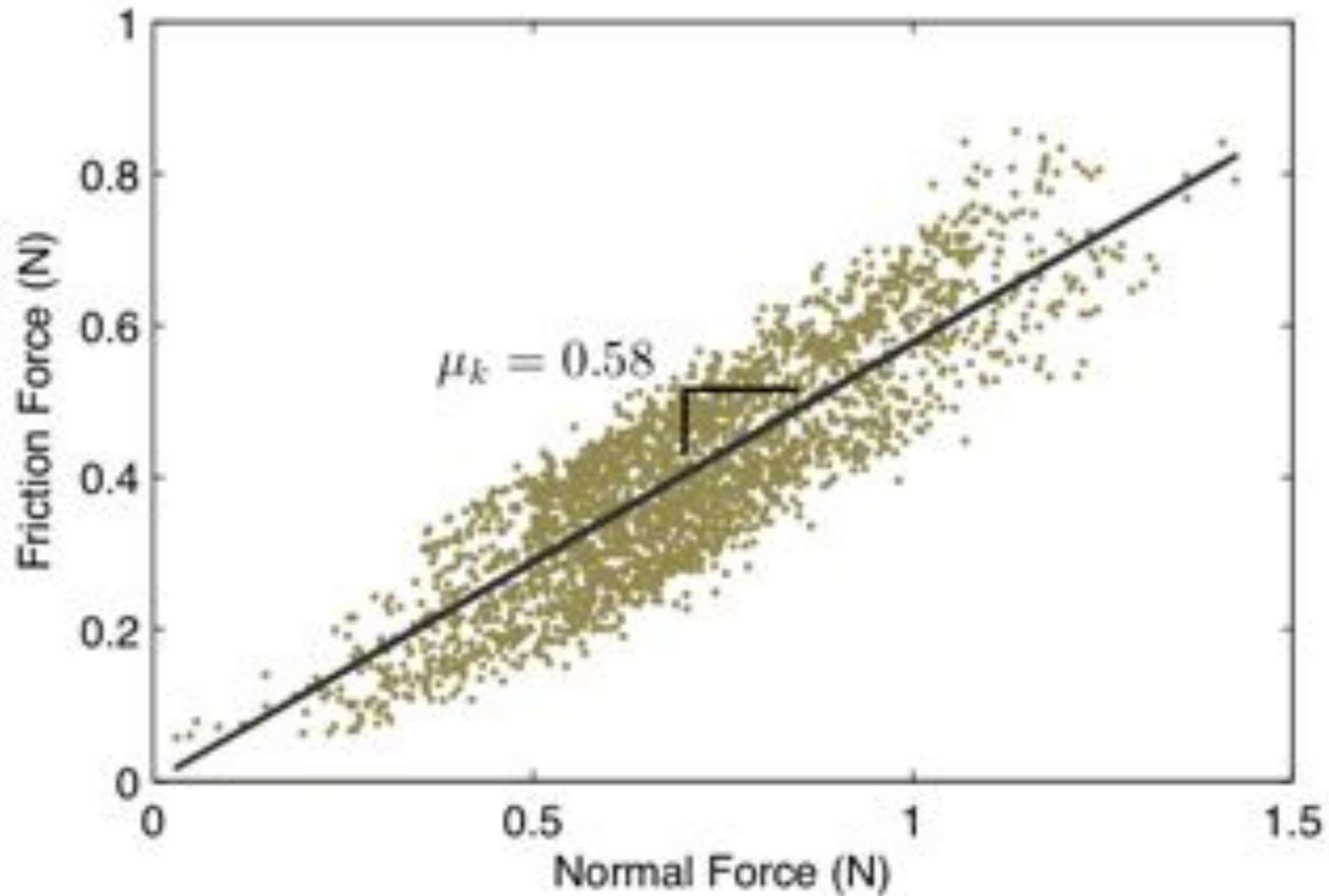

# Summary of Data Processing

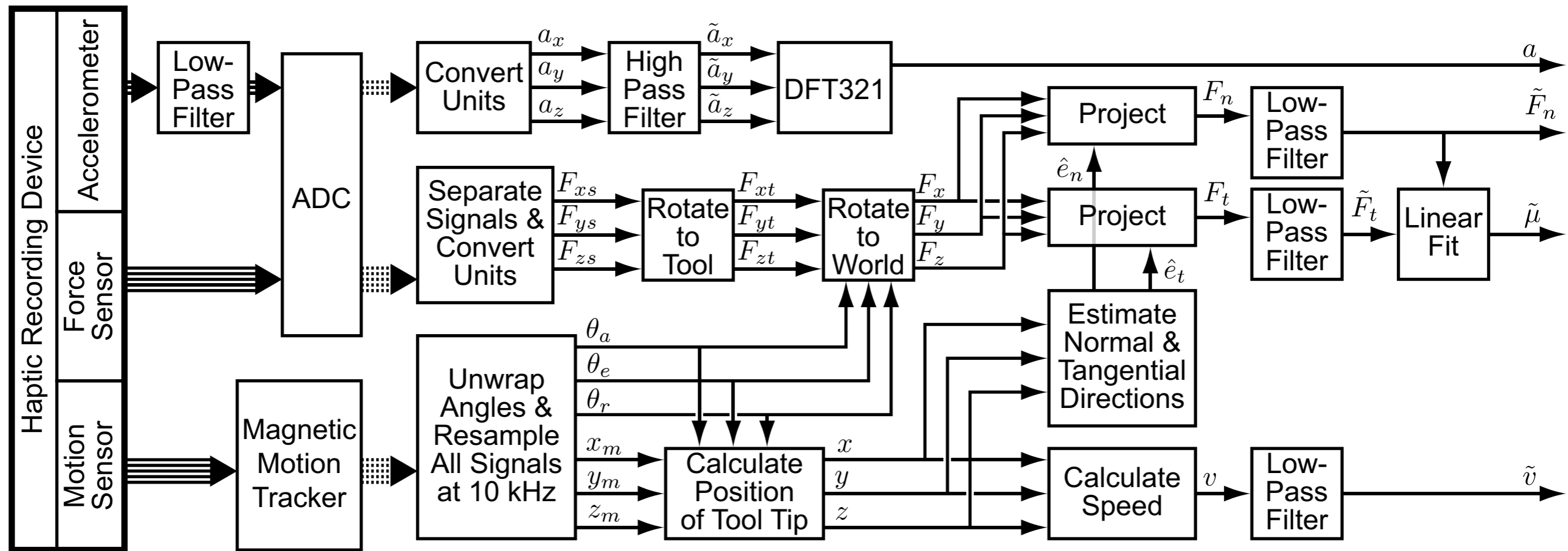

[13] Heather Culbertson, Juliette Unwin, and Katherine J. Kuchenbecker. Modeling and rendering realistic textures from unconstrained tool-surface interactions, 2014. Under revisions for *IEEE Transactions on Haptics*.



# Texture Modeling

# Recorded Data

– Acceleration

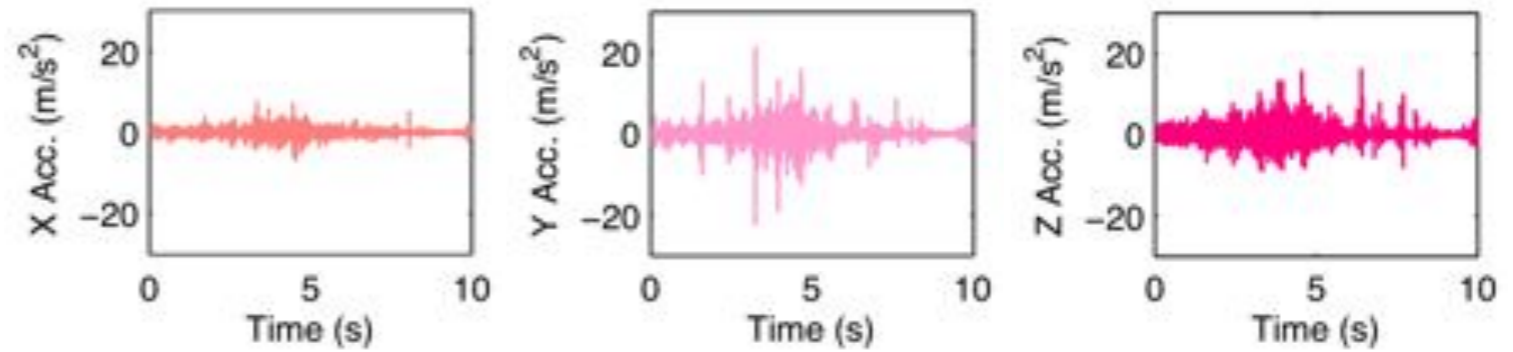

– Position

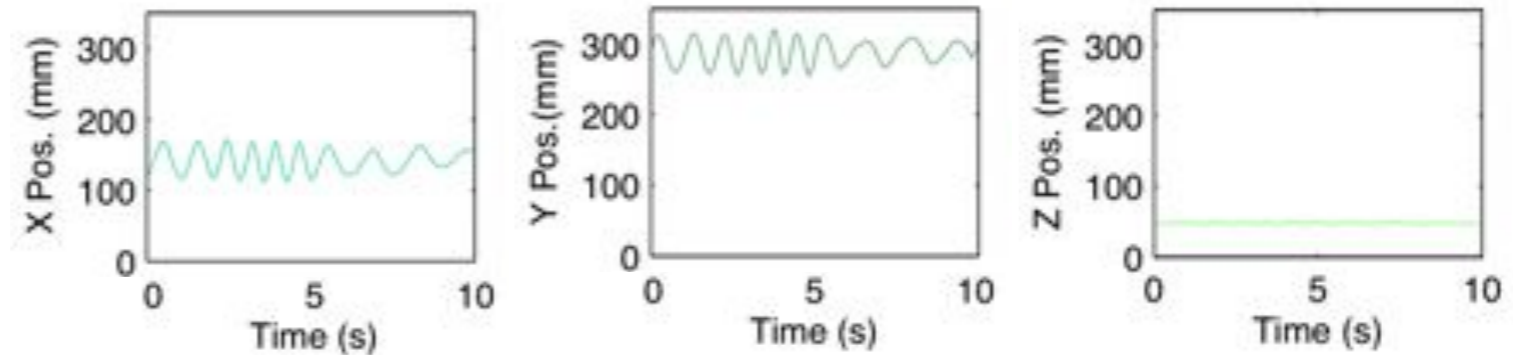

– Orientation

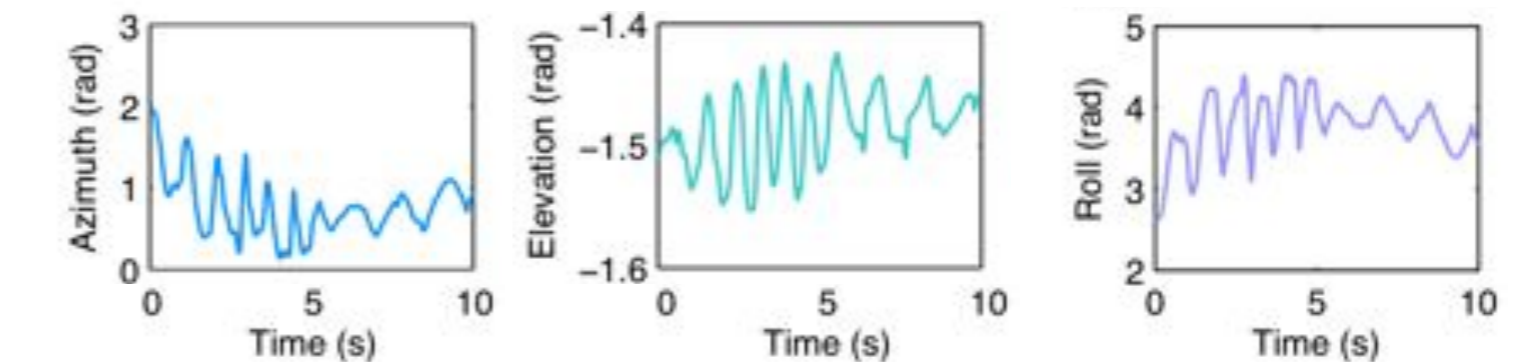

– Force

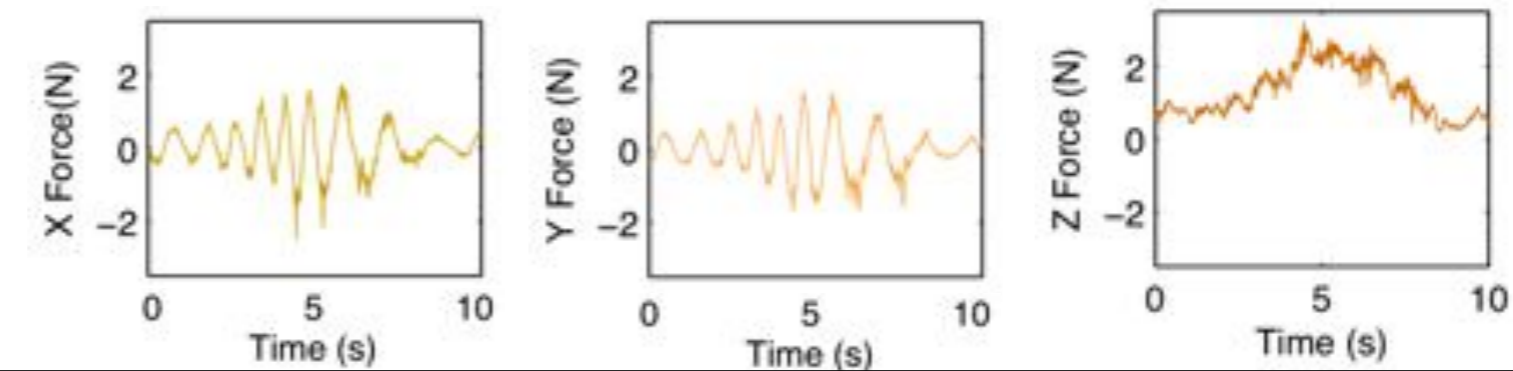

# Acceleration Processing

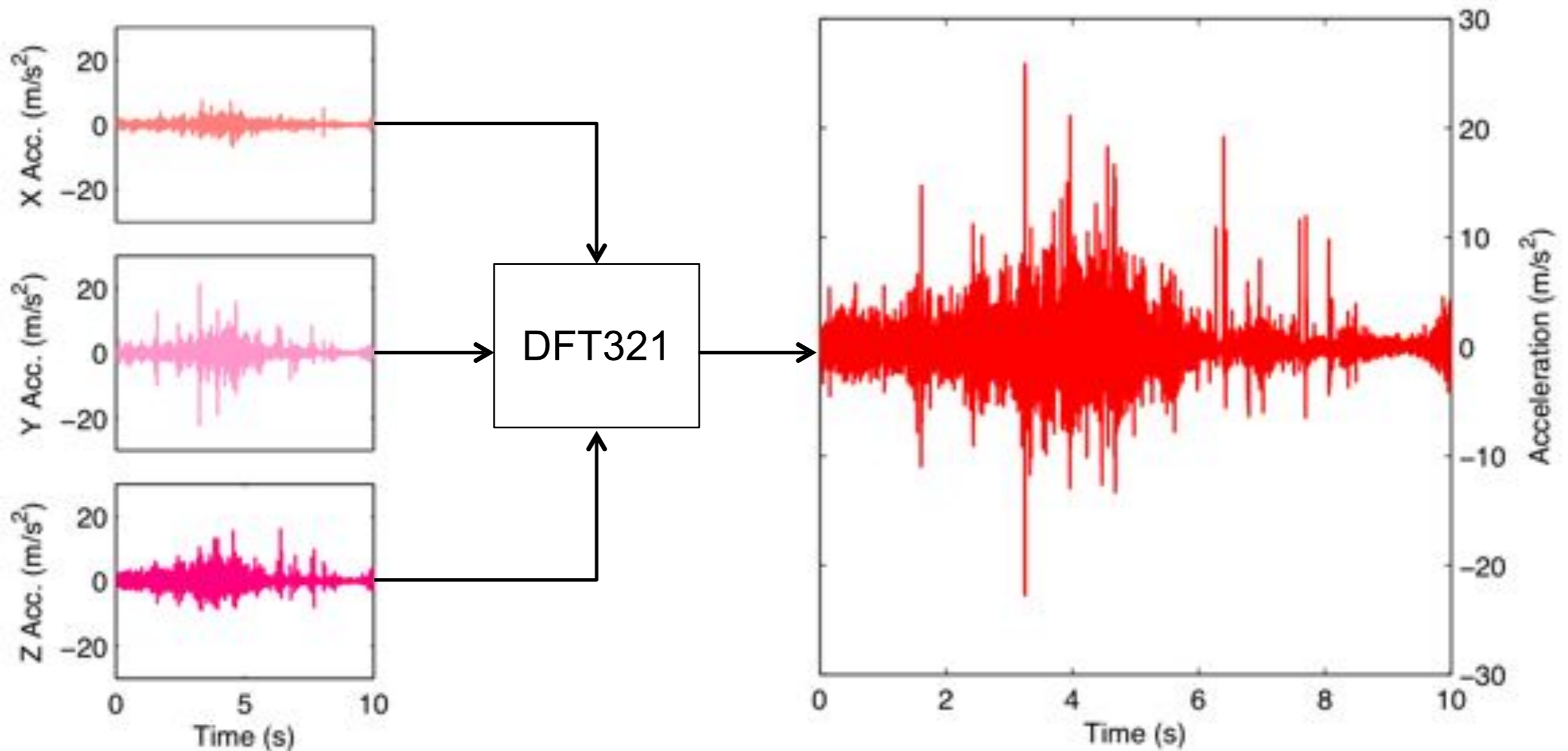

[6] Nils Landin, Joseph M. Romano, William McMahan, and Katherine J. Kuchenbecker. Dimensional reduction of high-frequency accelerations for haptic rendering. In Astrid Kappers, Jan van Erp, Wouter Bergmann Tiest, and Frans van der Helm, editors, *Haptics: Generating and Perceiving Tangible Sensations, Proc. EuroHaptics, Part II*, volume 6192 of *Lecture Notes in Computer Science*, pp. 79–86. Springer, July 2010.

# Speed Calculation

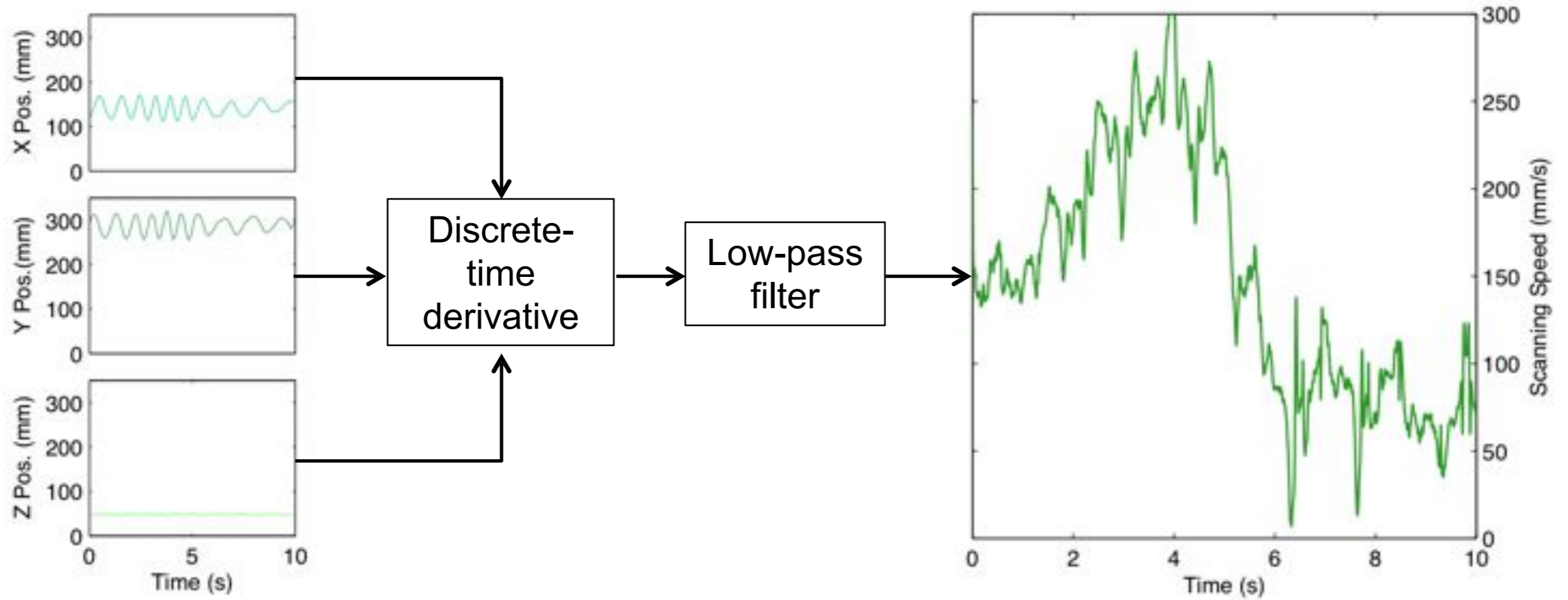

# Force Processing

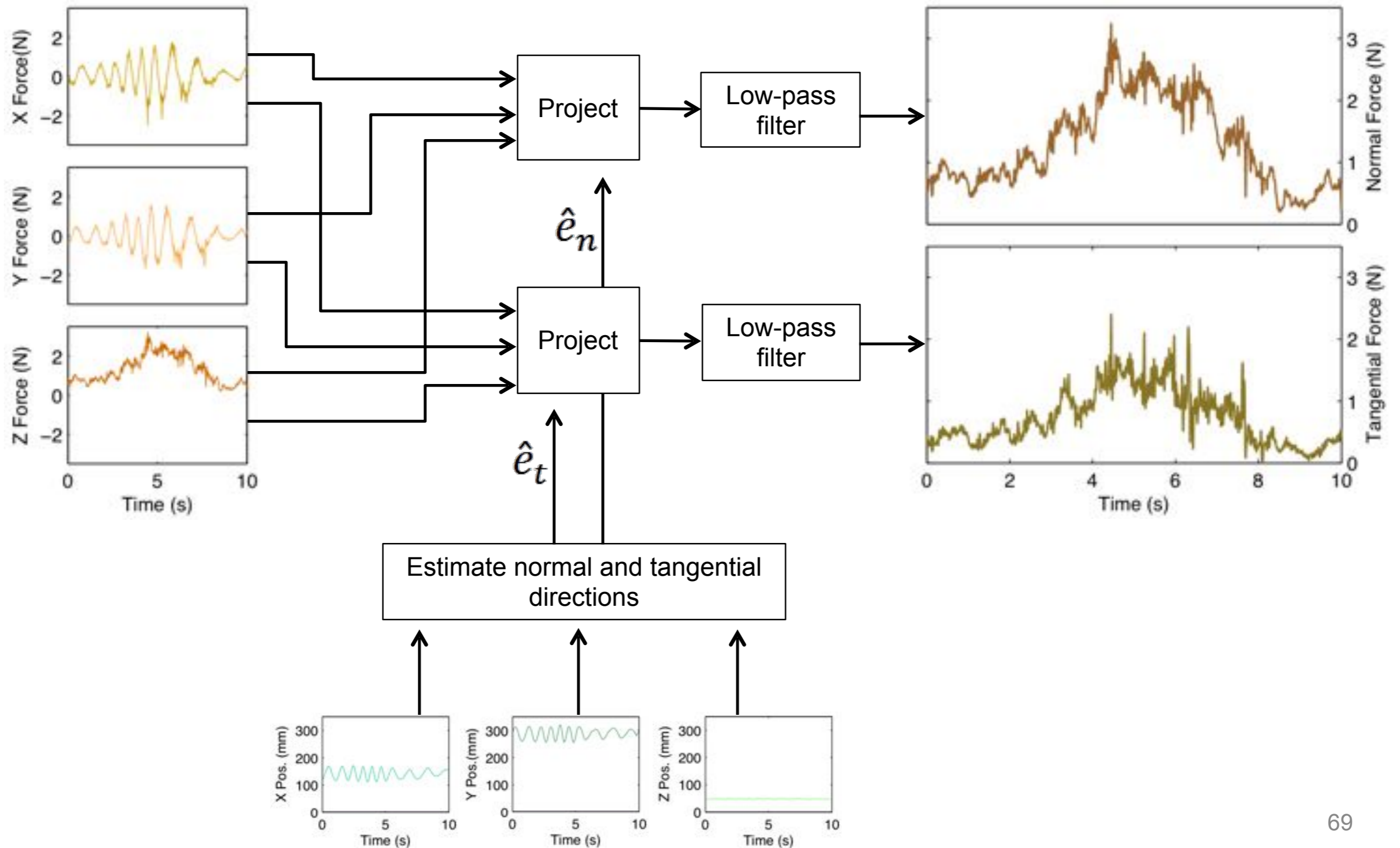

# Model Structure

- Autoregressive (AR)
  - All-pole infinite impulse response (IIR) filter
- Next output is a linear combination of previous outputs

$$H(z) = \frac{1}{1 - \sum_{k=1}^p A_k z^{-k}}$$

# Components of AR model

- AR Coefficients

$$\{A_1, A_2, \dots, A_p\}$$

- Variance

$$\text{var} = \sum_{n=1}^N (y_n - A_1 y_{n-1} - \dots - A_p y_{n-p} - e_n)^2$$

[5] Joseph M. Romano, Takashi Yoshioka, and Katherine J. Kuchenbecker. Automatic filter design for synthesis of haptic textures from recorded acceleration data. In *Proc. IEEE International Conference on Robotics and Automation*, pp. 1815–1821. May 2010.

# Motivation for segmentation

- Acceleration signal not stationary
  - Power and frequency content depend on force and speed
- AR model structure requires assumption of strong stationarity
  - Break signal into stationary segments
  - Create AR model for each segment

[9] Heather Culbertson, Juliette Unwin, Benjamin E. Goodman, and Katherine J. Kuchenbecker. Generating haptic texture models from unconstrained tool-surface interactions. In *Proc. IEEE World Haptics Conference*, pp. 295–300. April 2013.



# Segmenting Algorithm

- Auto-PARM algorithm\*
  - Genetic algorithm
  - Optimize minimum description length (MDL)

$$\text{MDL} = \log(m) + (m + 1)\log(n) + \sum_{j=1}^{m+1} \log(p_j) + \sum_{j=1}^{m+1} \frac{p_j + 2}{2} \log(n_j) + \sum_{j=1}^{m+1} \frac{n_j}{2} \log(2\pi\sigma_j^2)$$

# Segmentation

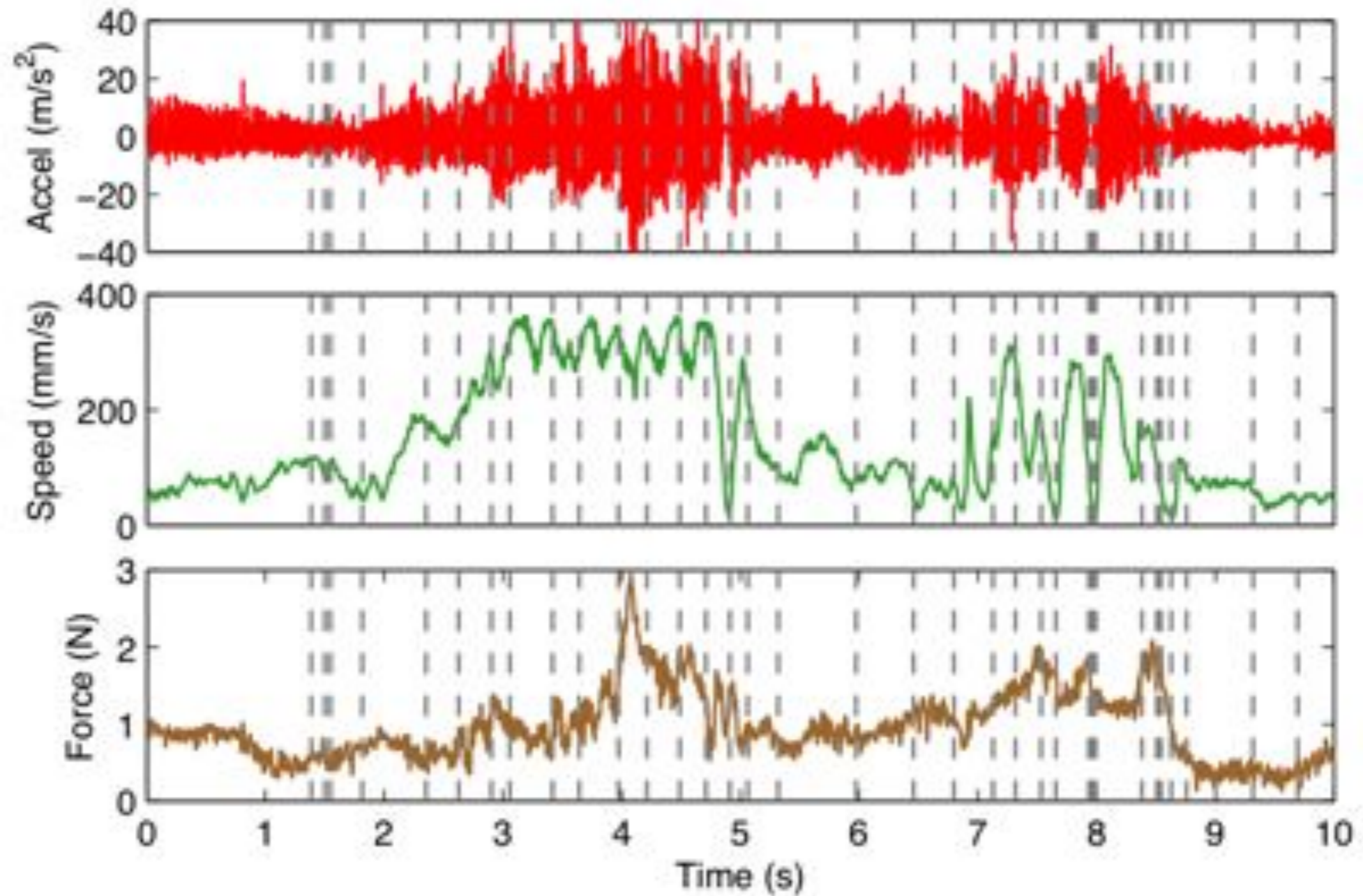

# Modeling a segment

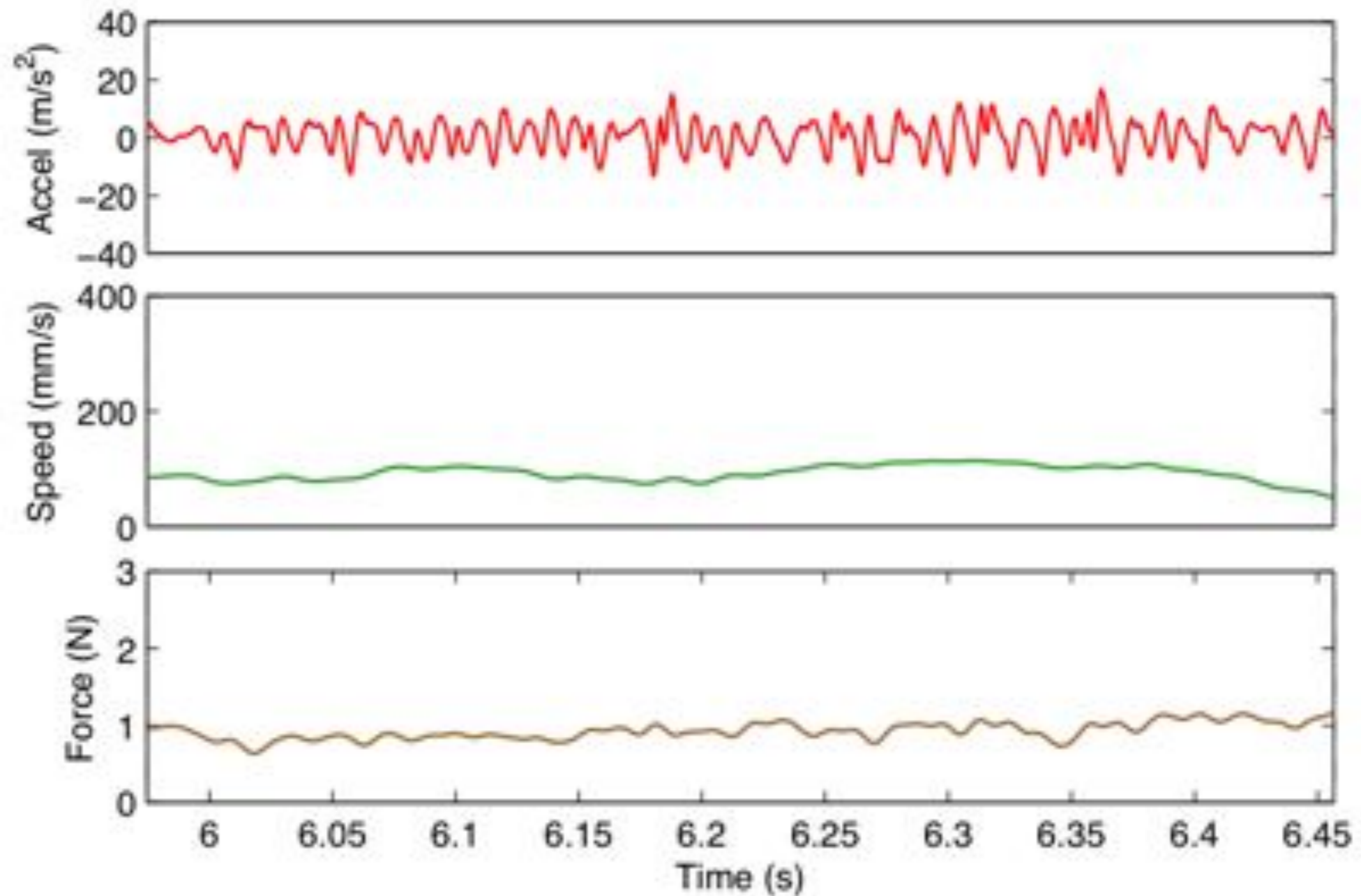

# Modeling a segment

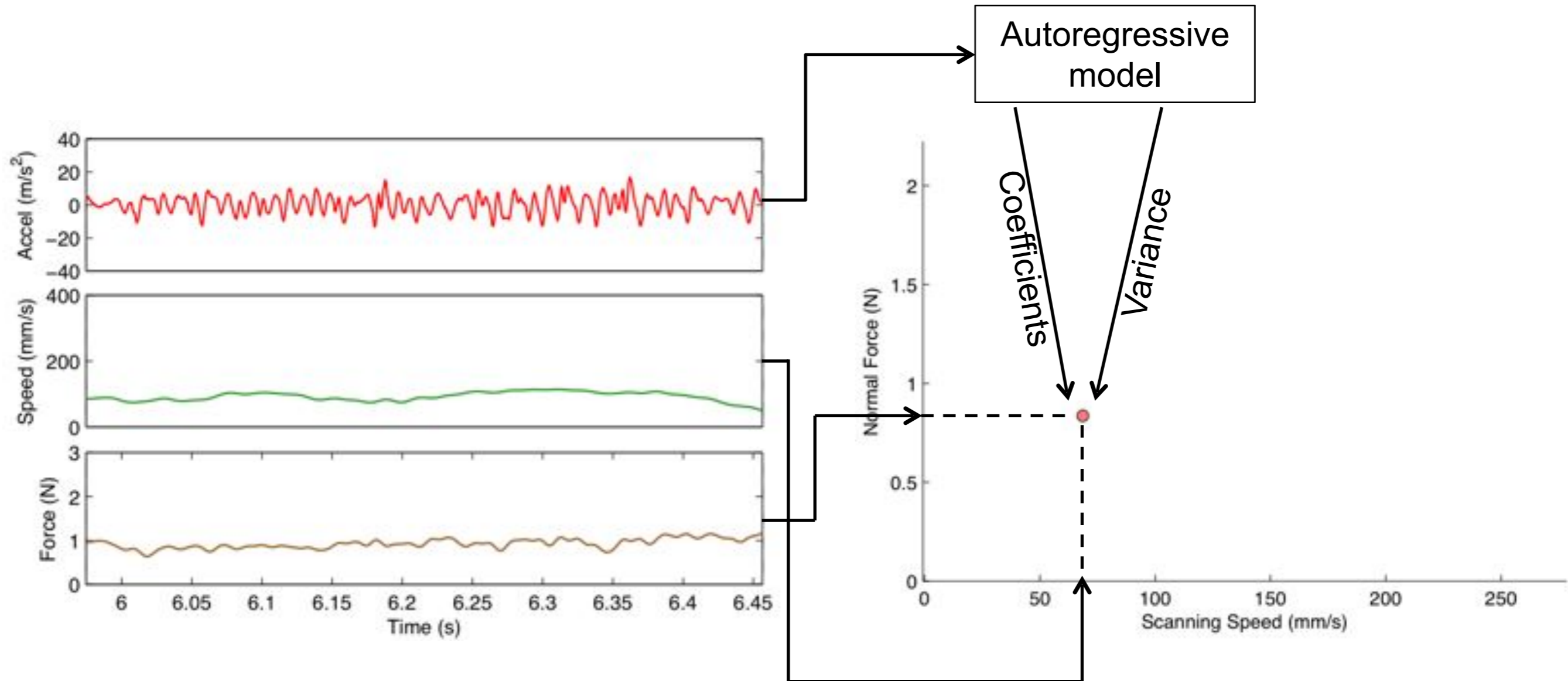

# Model Storage

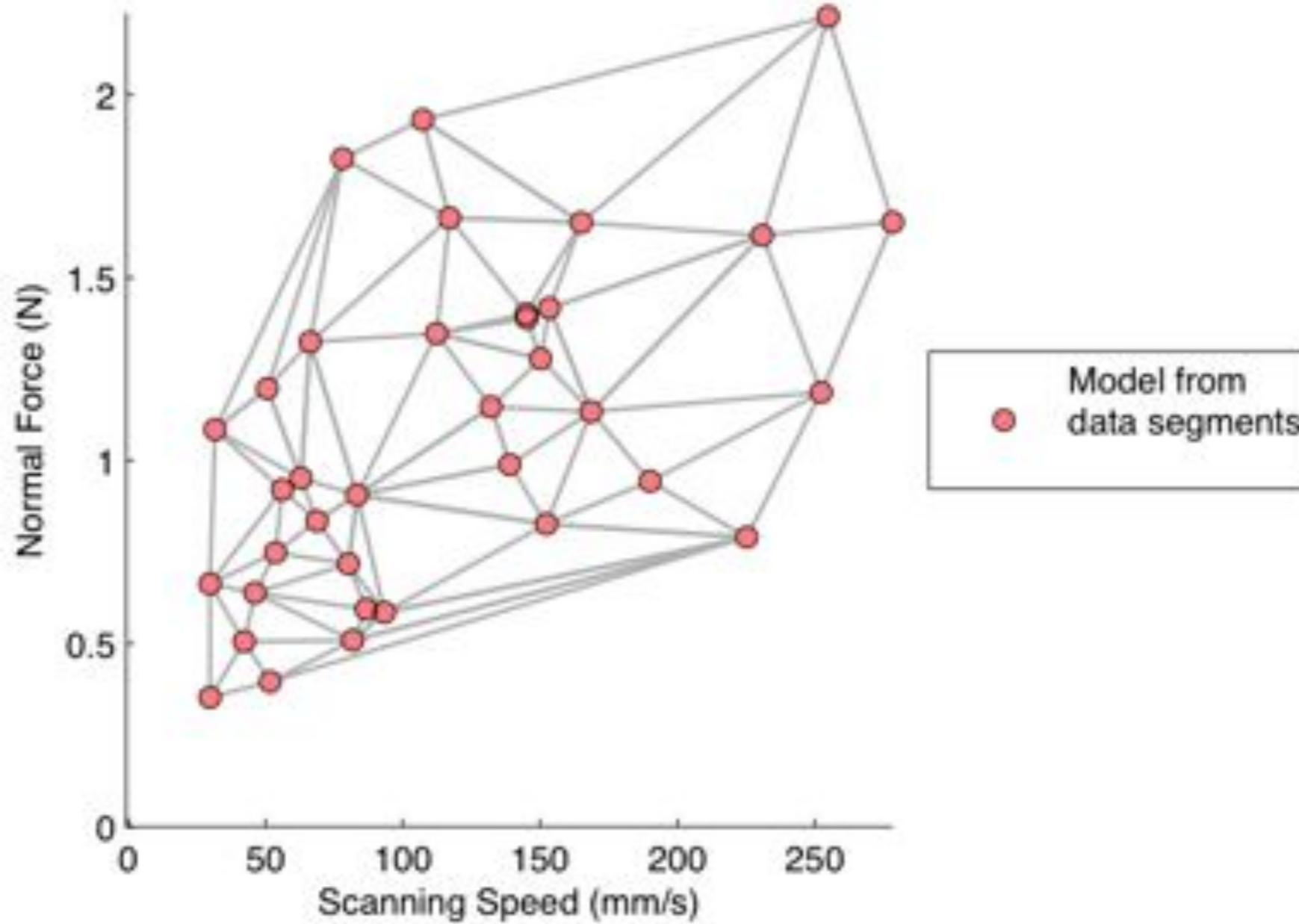

# Model Storage

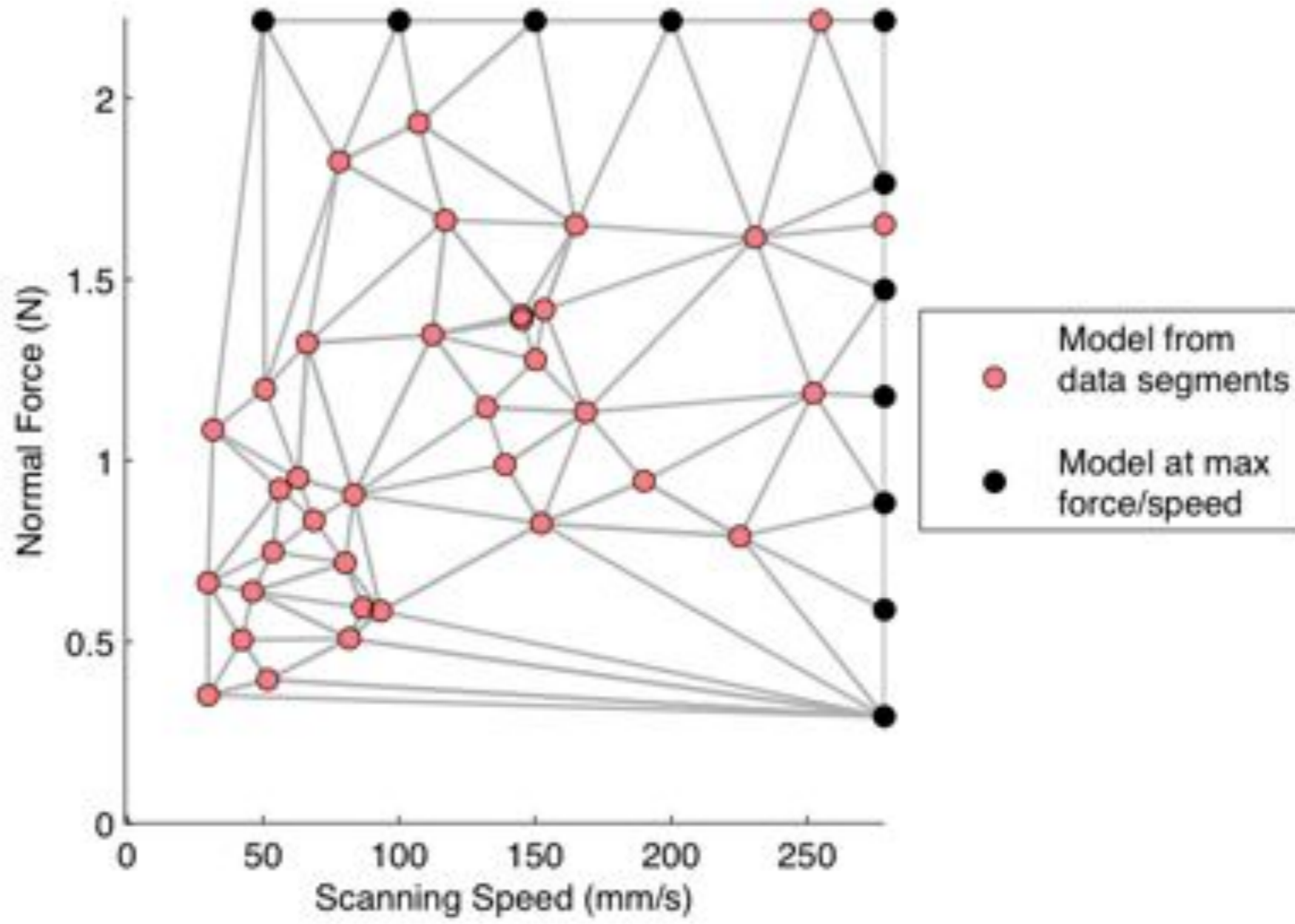

# Model Storage

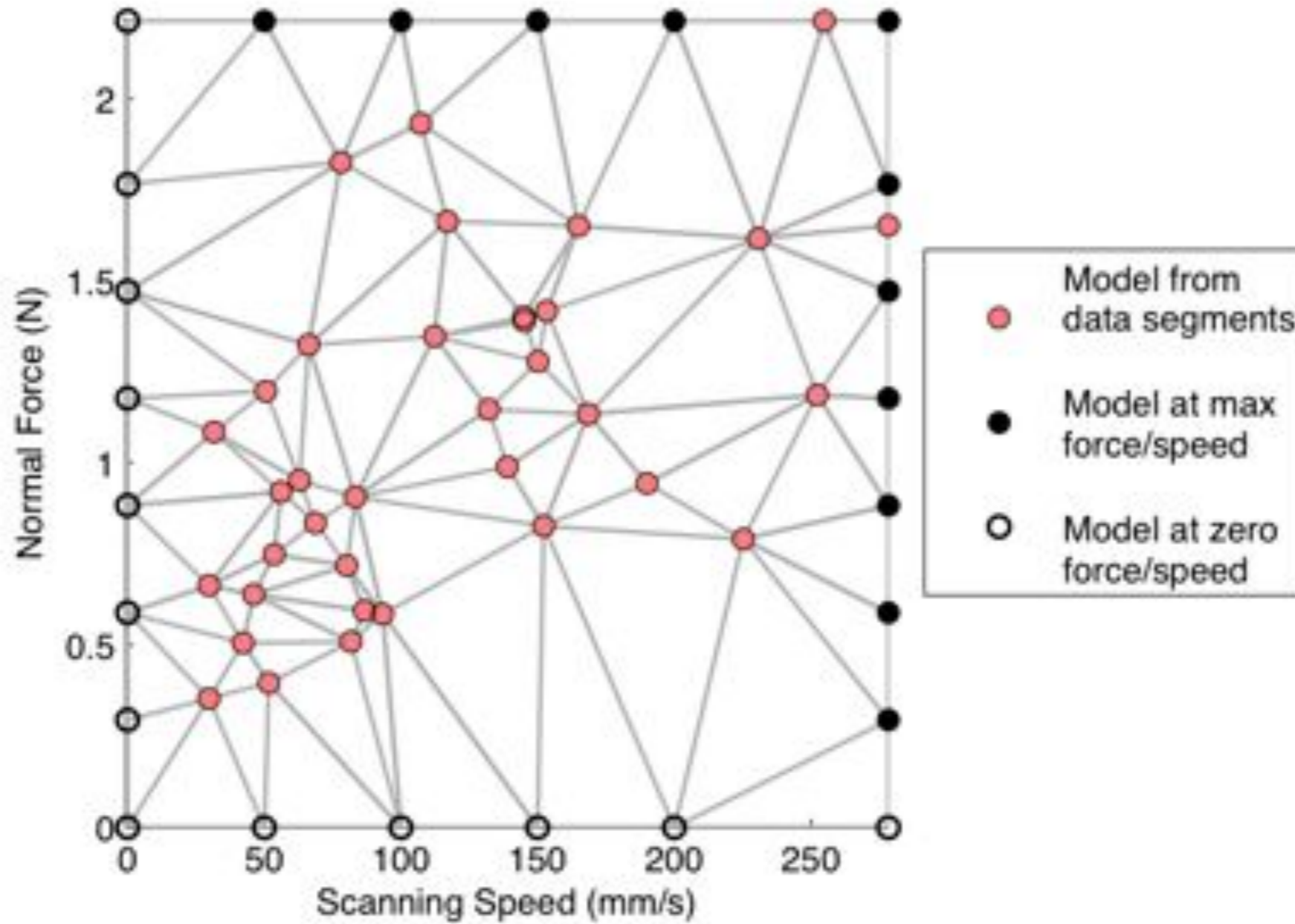

# Summary of Texture Modeling

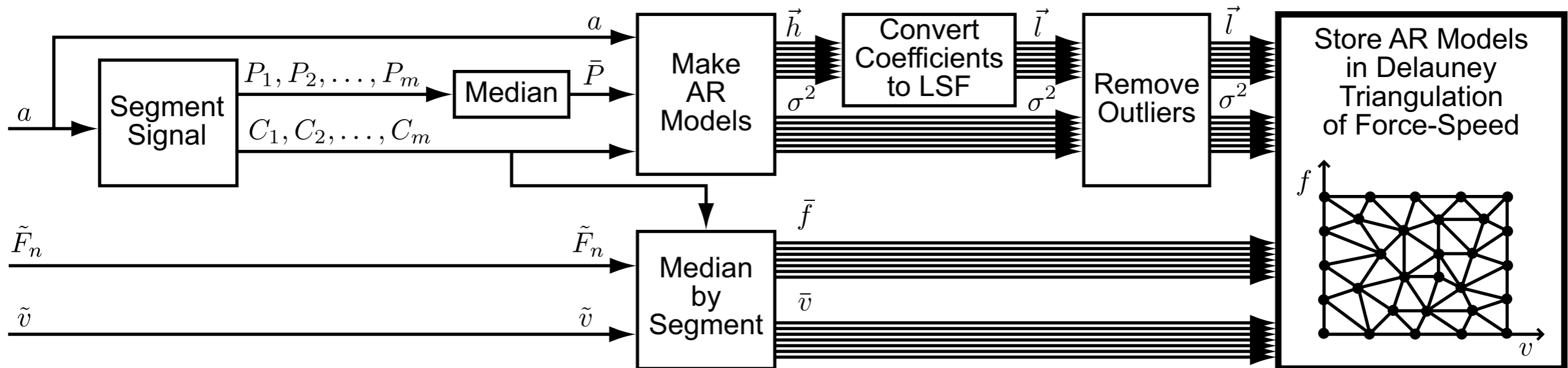

[13] Heather Culbertson, Juliette Unwin, and Katherine J. Kuchenbecker. Modeling and rendering realistic textures from unconstrained tool-surface interactions, 2014. Under revisions for *IEEE Transactions on Haptics*.



# Texture Signal Generation

# AR Models in Delaunay Triangulation by Normal Force and Scanning Speed

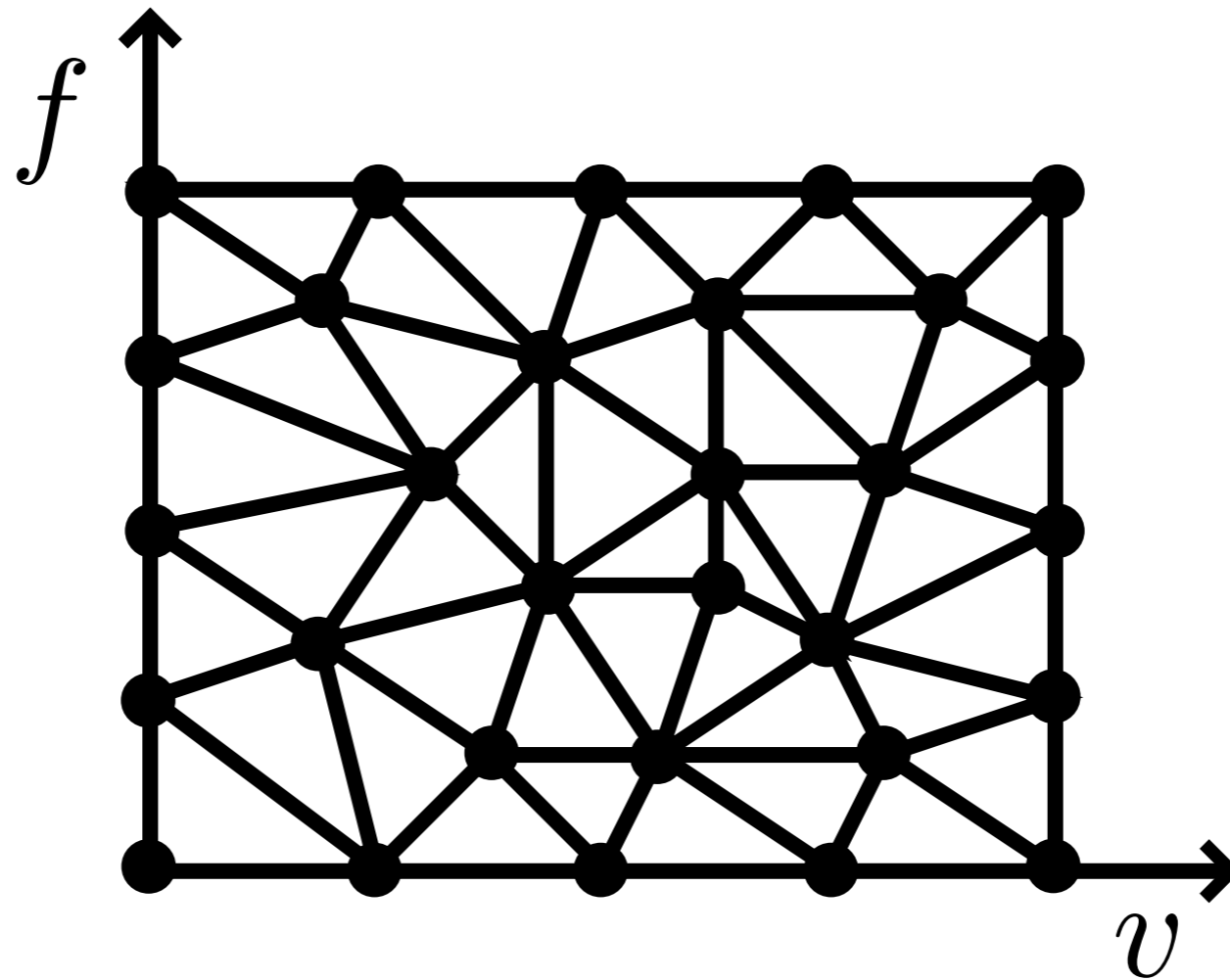

The haptic rendering system must continually measure the user's normal force and scanning speed.

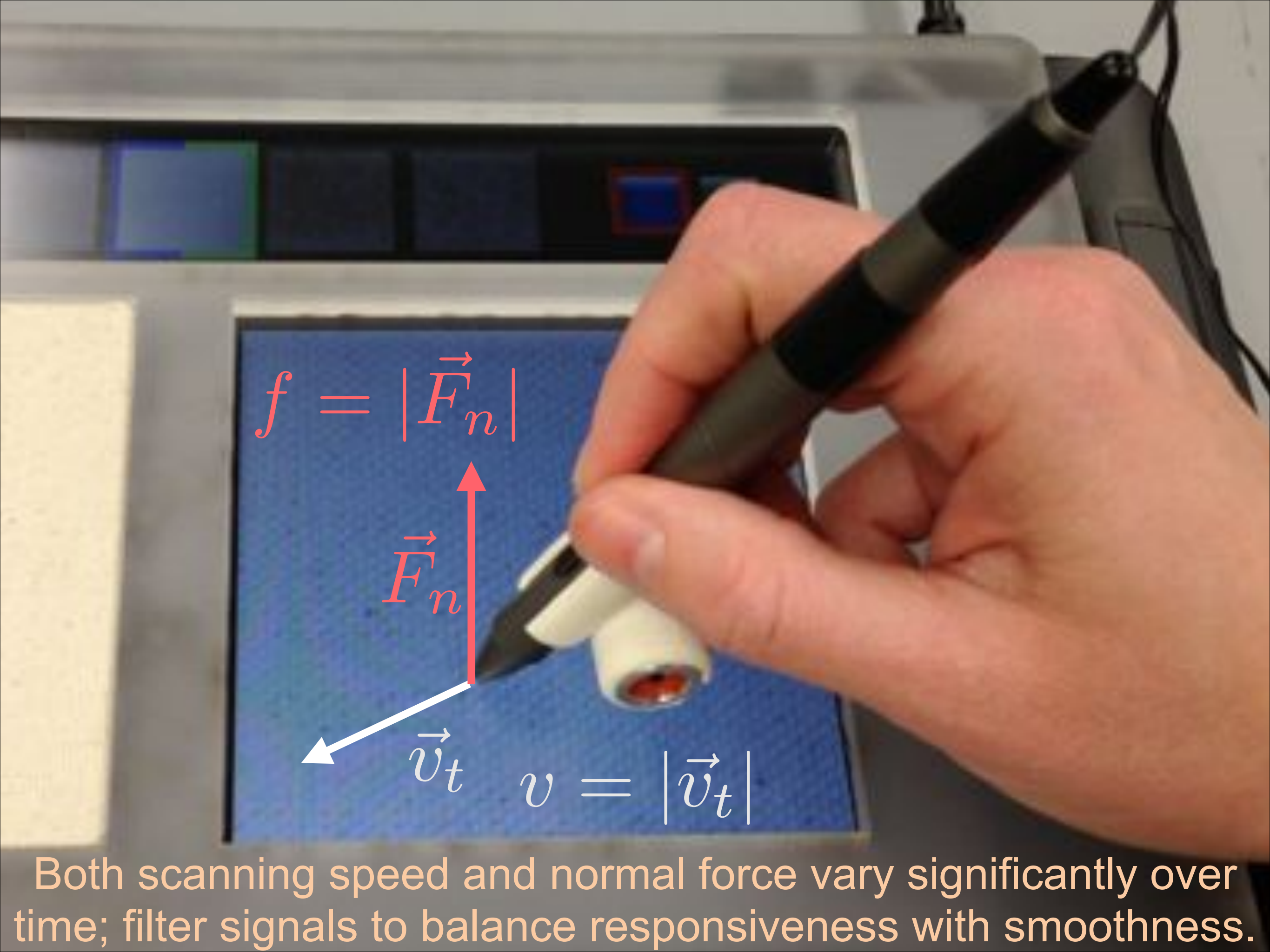
A hand holding a black marker is pointing at a blue surface. Overlaid on the blue surface are two vector diagrams. The first diagram shows a red vector labeled  $\vec{F}_n$  pointing upwards from the tip of the marker. Above it is the equation  $f = |\vec{F}_n|$  in red. The second diagram shows a white vector labeled  $\vec{v}_t$  pointing downwards and to the left from the tip of the marker. Below it is the equation  $v = |\vec{v}_t|$  in white.
$$f = |\vec{F}_n|$$

$$\vec{F}_n$$

$$\vec{v}_t$$

$$v = |\vec{v}_t|$$

Both scanning speed and normal force vary significantly over time; filter signals to balance responsiveness with smoothness.

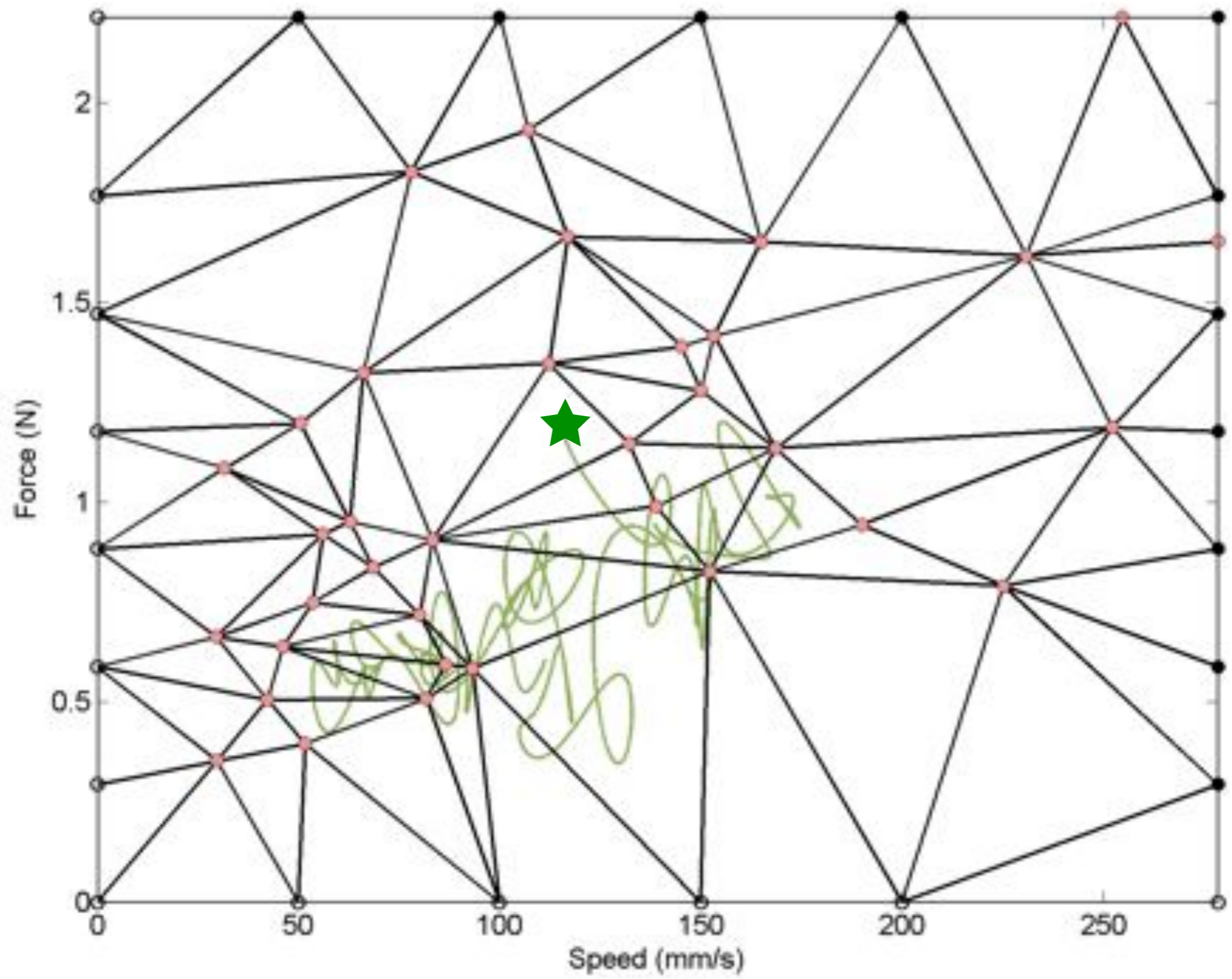

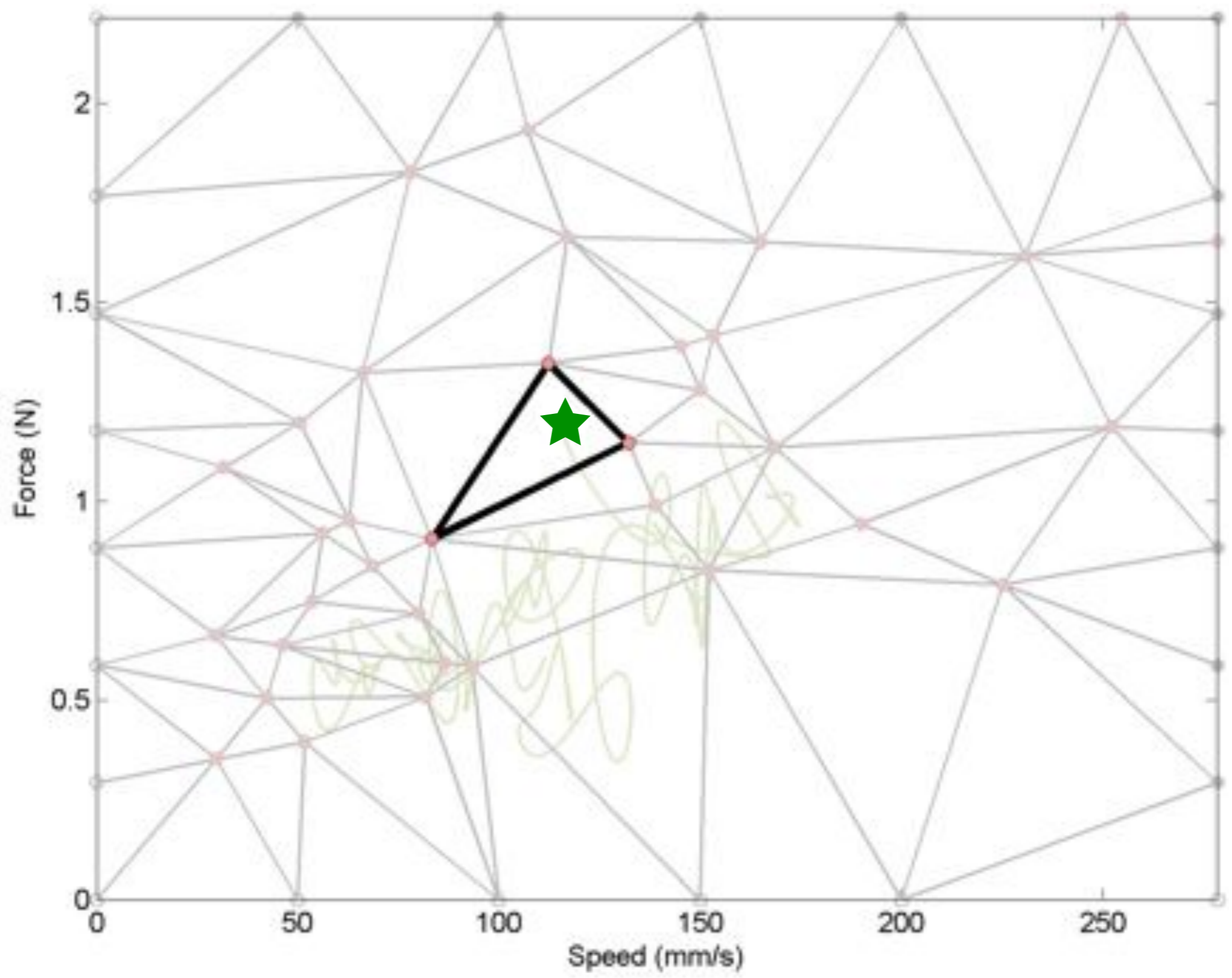

# Calculate Filter Coefficients and White Noise Variance

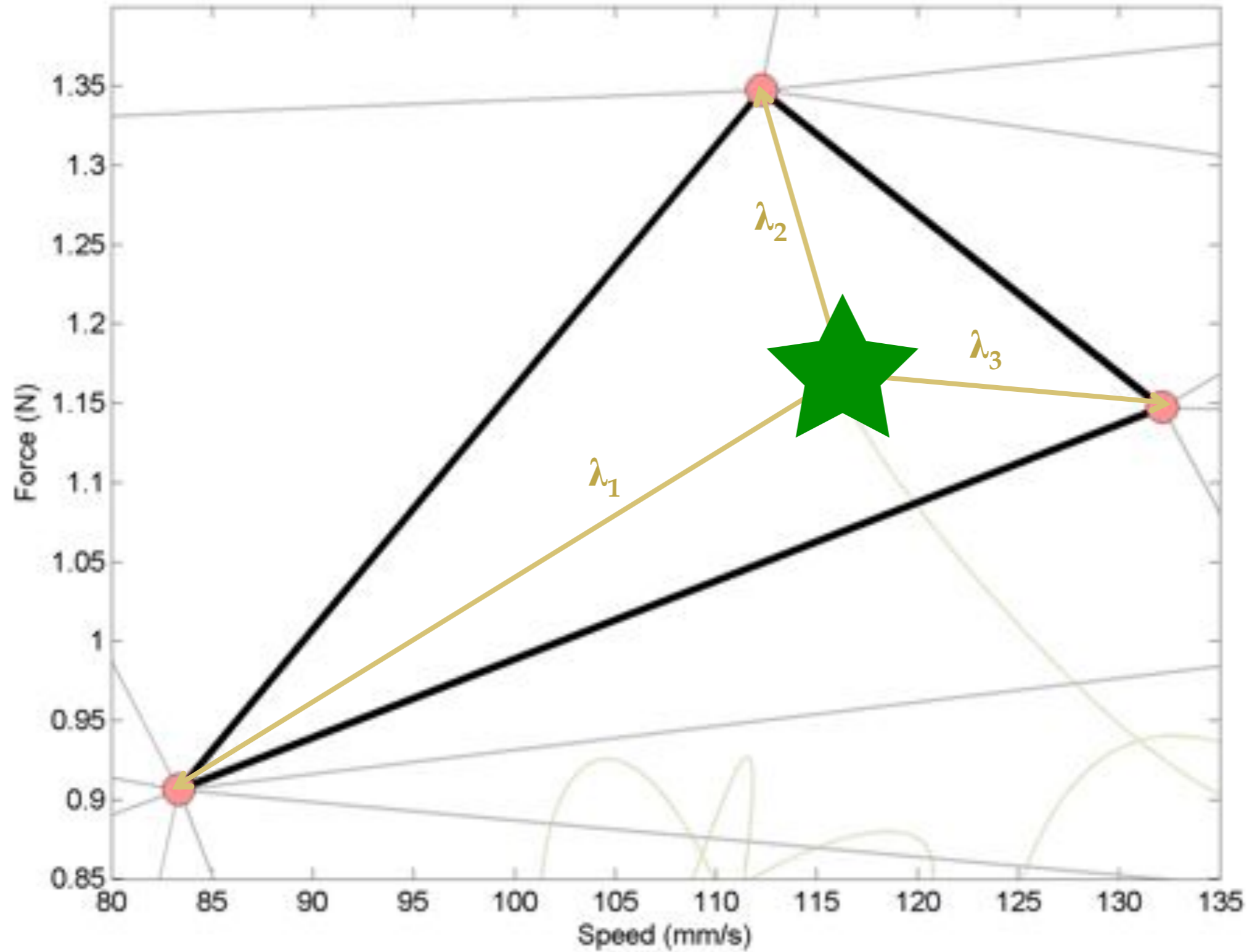

# Interpolation must be done on Line Spectral Frequencies instead of coefficients to preserve stability.

Interpolate Coefficients

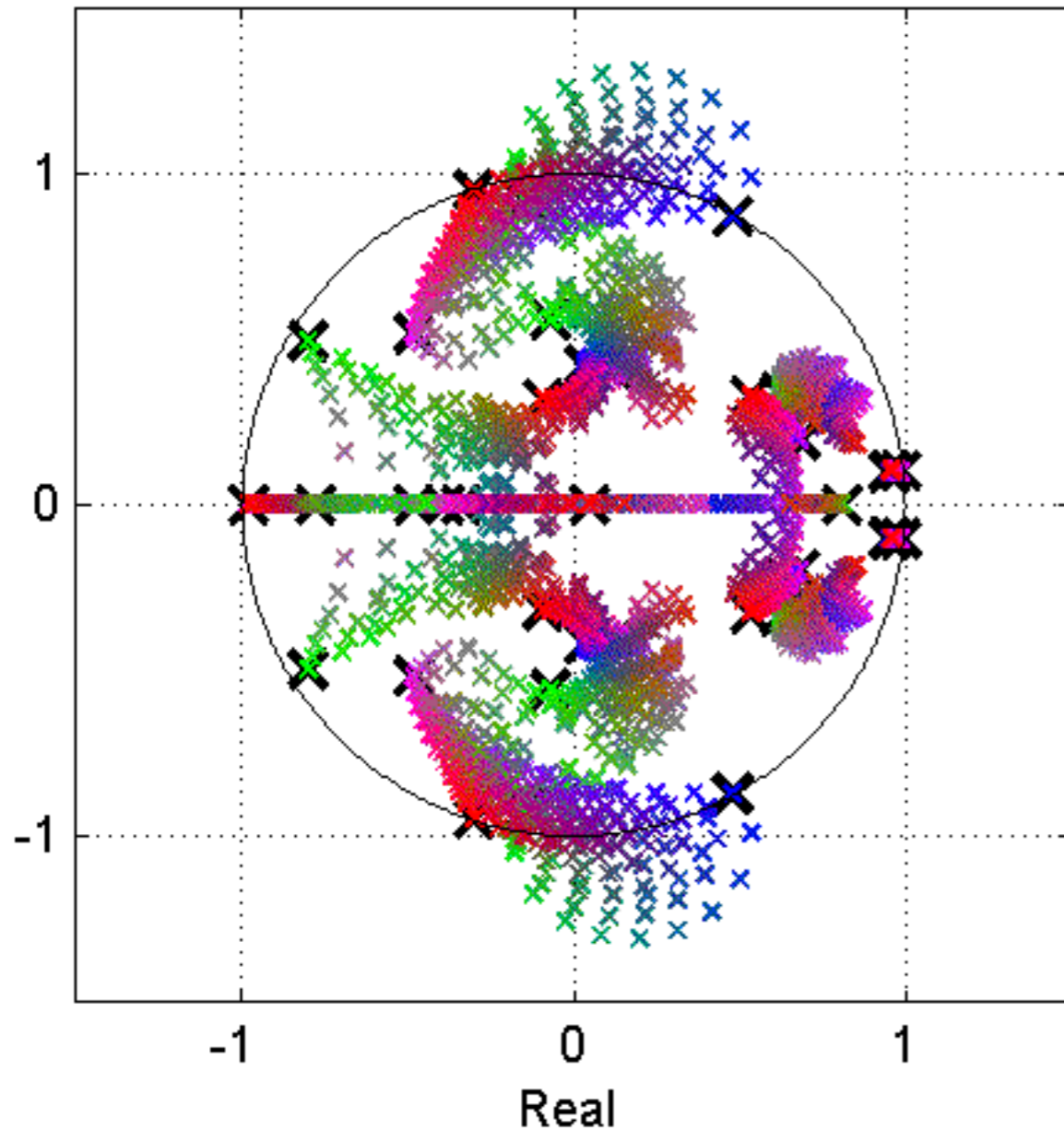

Interpolate LSFs

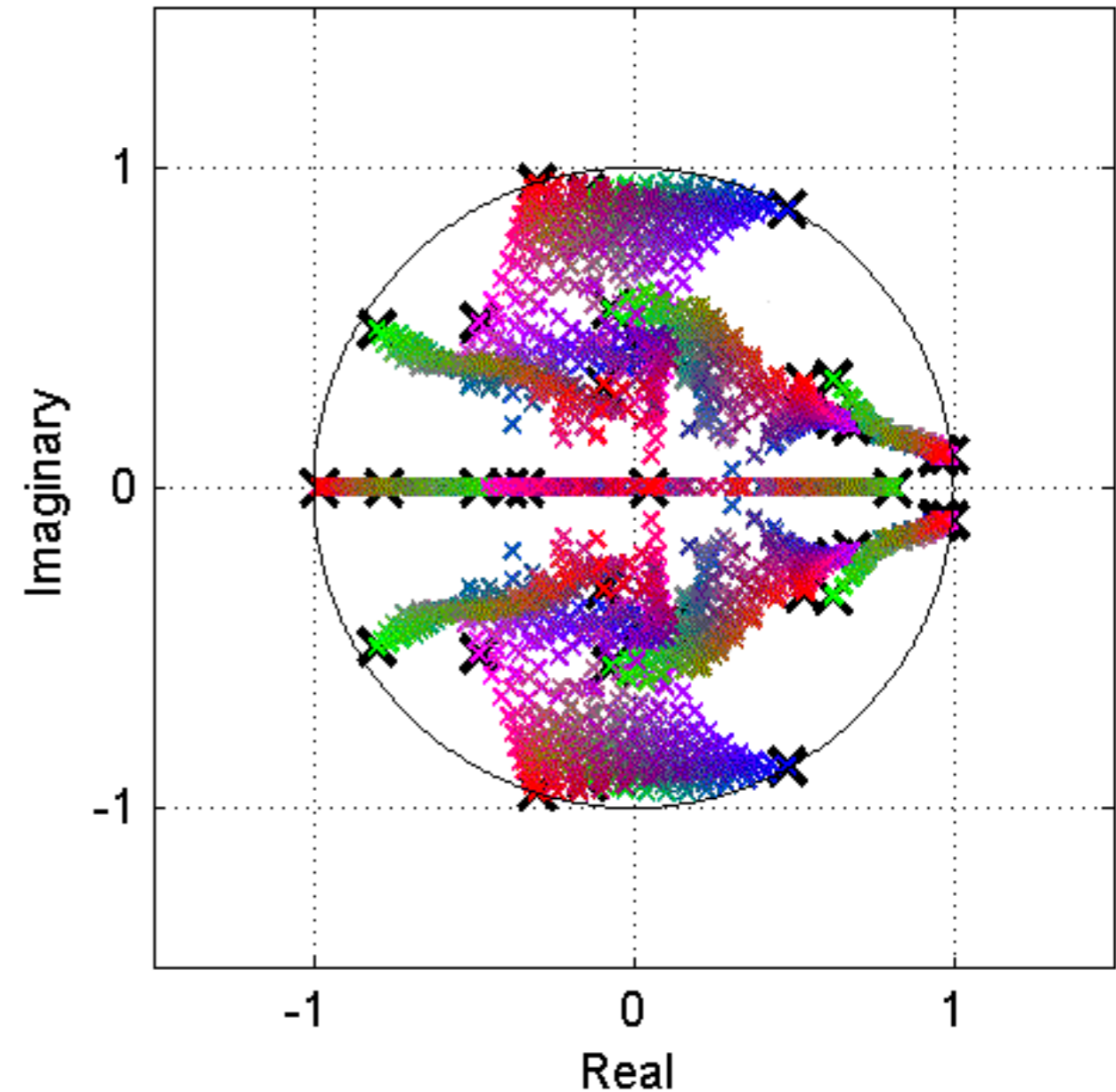

[7] Heather Culbertson, Joseph M. Romano, Pablo Castillo, Max Mintz, and Katherine J. Kuchenbecker. Refined methods for creating realistic haptic virtual textures from tool-mediated contact acceleration data. In *Proc. IEEE Haptics Symposium*, pp. 385–391. March 2012.

Create White Gaussian Noise with Calculated Variance (Magnitude)

White-Noise Variance Changes Over Time

Pass WGN Through AR Filter with Calculated Coefficients (Frequency Response)

Yields a Unique Waveform Whose Spectrum Blends the Spectra of the Recorded Data from which the Three Models were Made

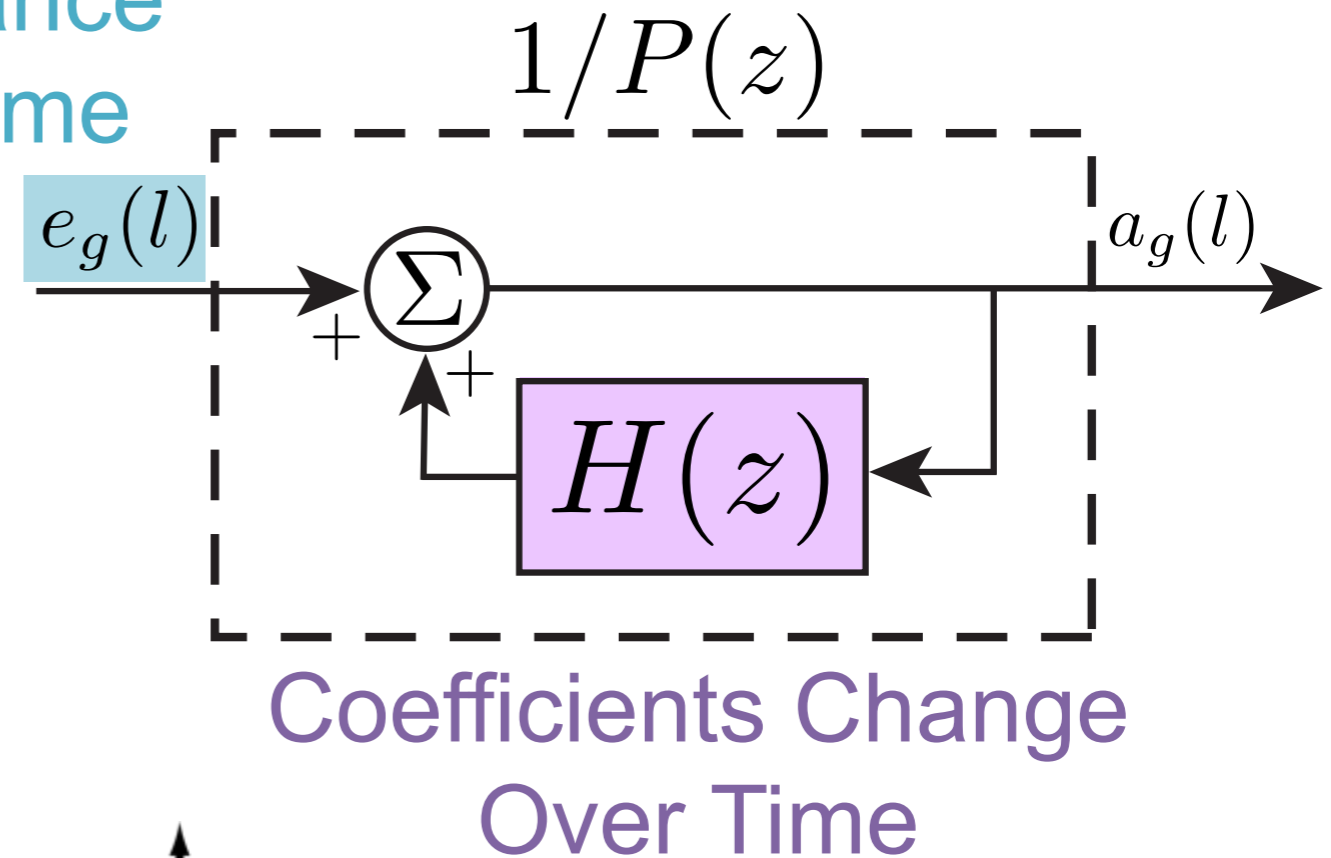
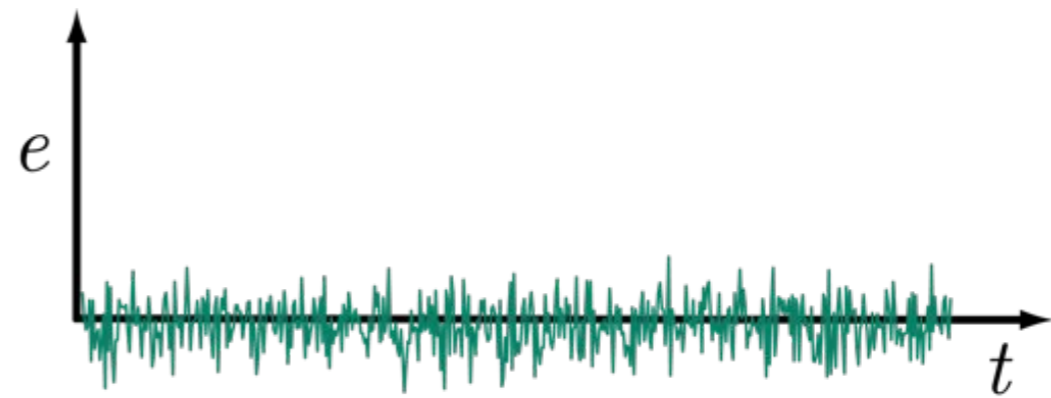



# Synthesizing a New Texture Output

## One Original Recording

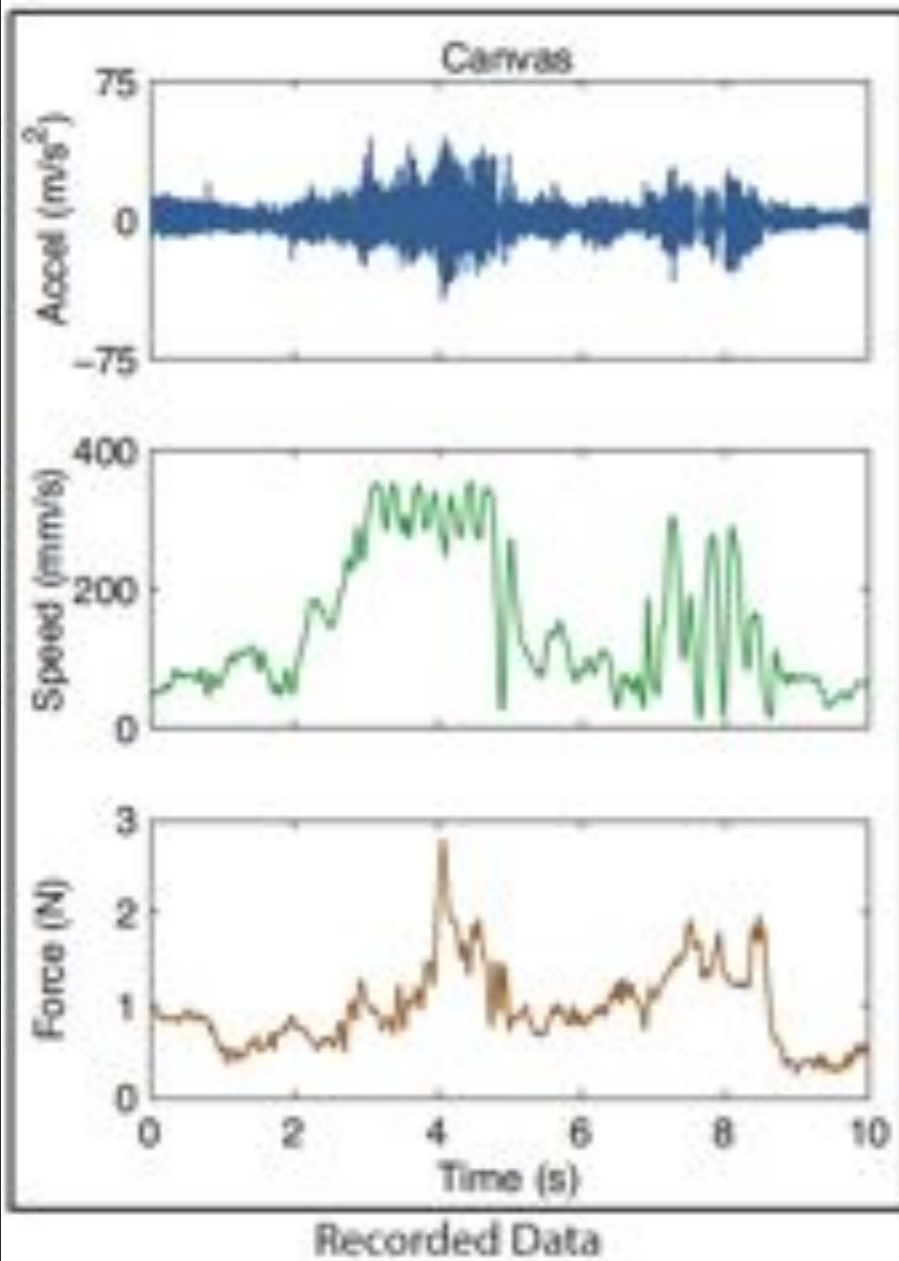

# Synthesizing a New Texture Output

One Original Recording

Six Synthetic Texture Signals

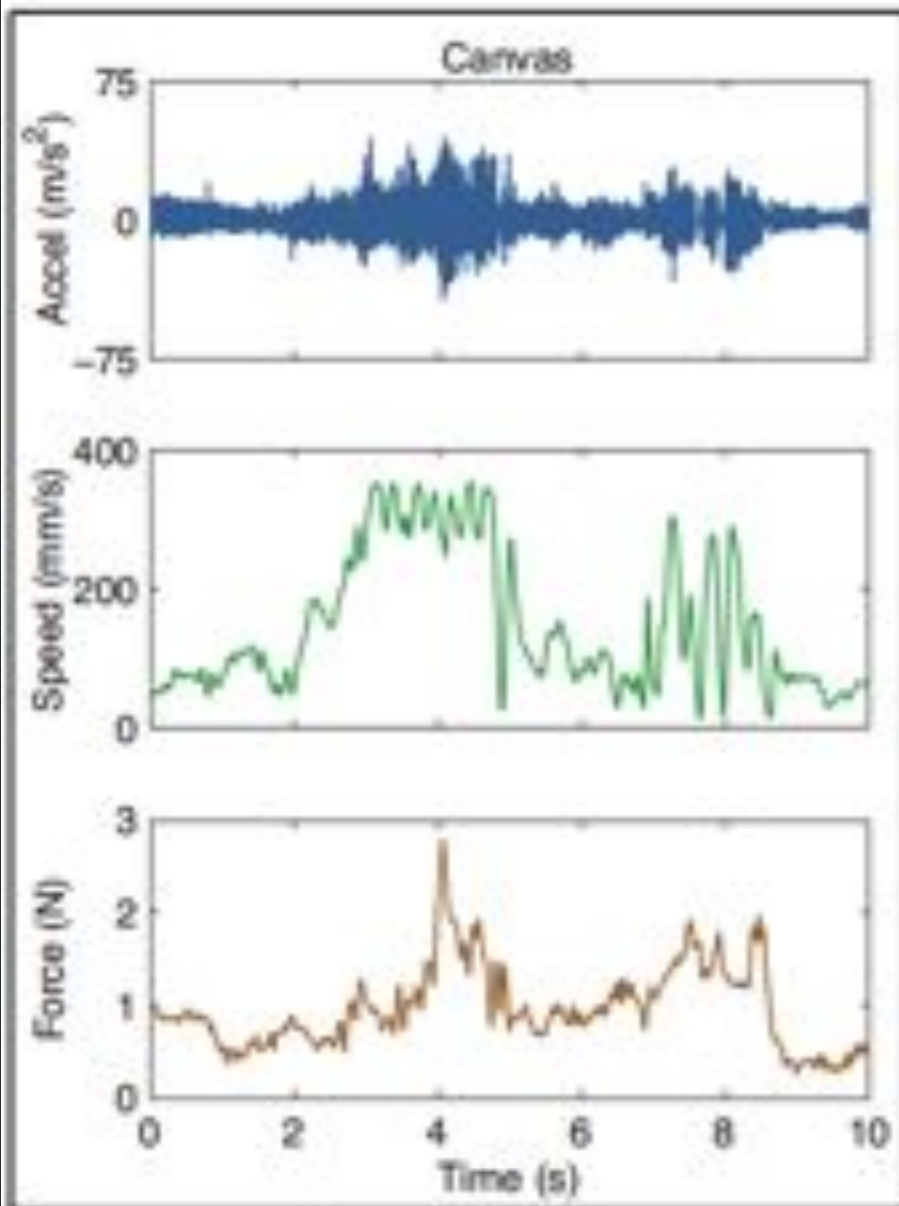

Recorded Data

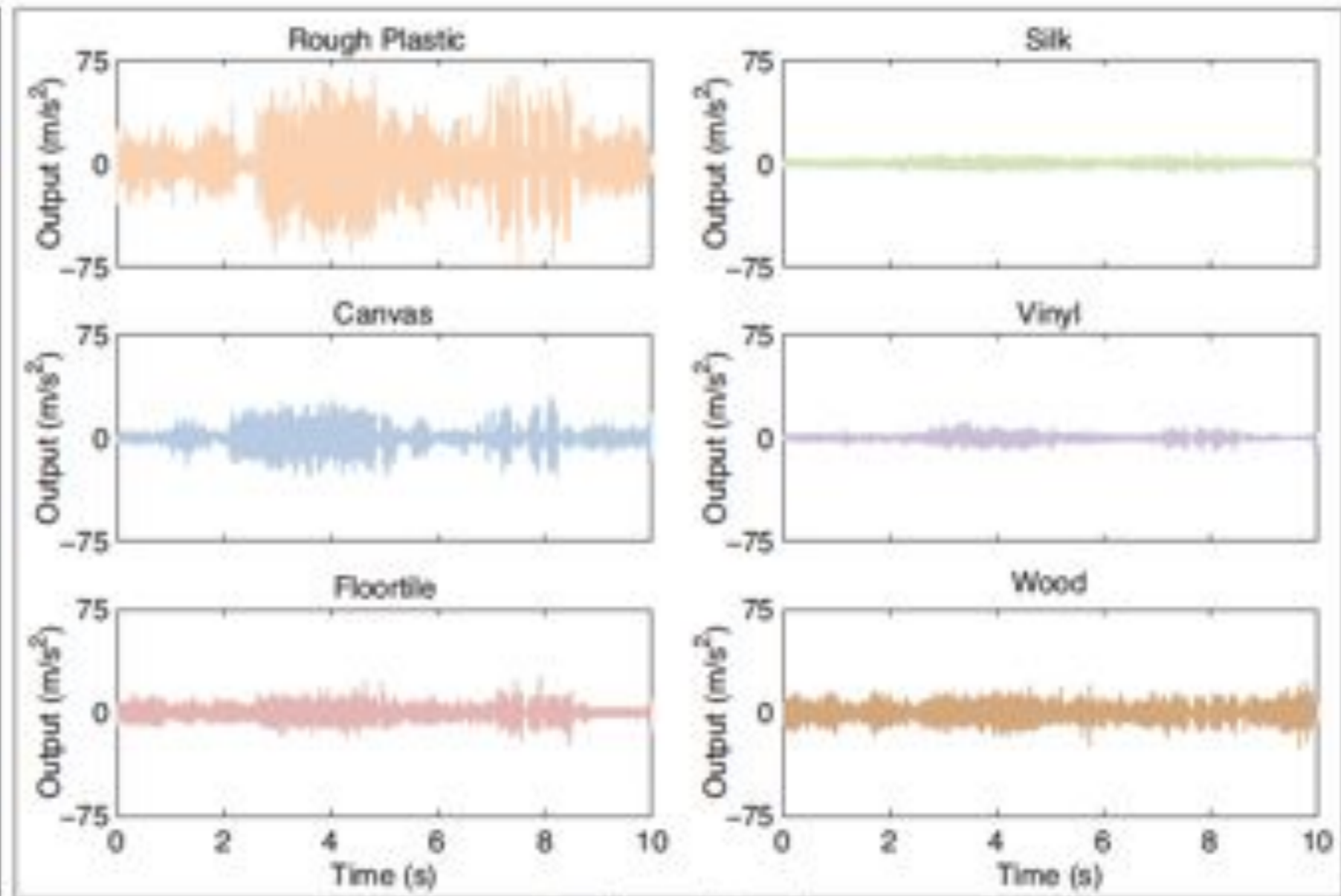

Synthesized Signals

Texture signal must be generated at 1000 Hz or faster.  
Interpolation can occur at a slower rate.

# Output Spectrum Matches Spectrum of Recorded Data

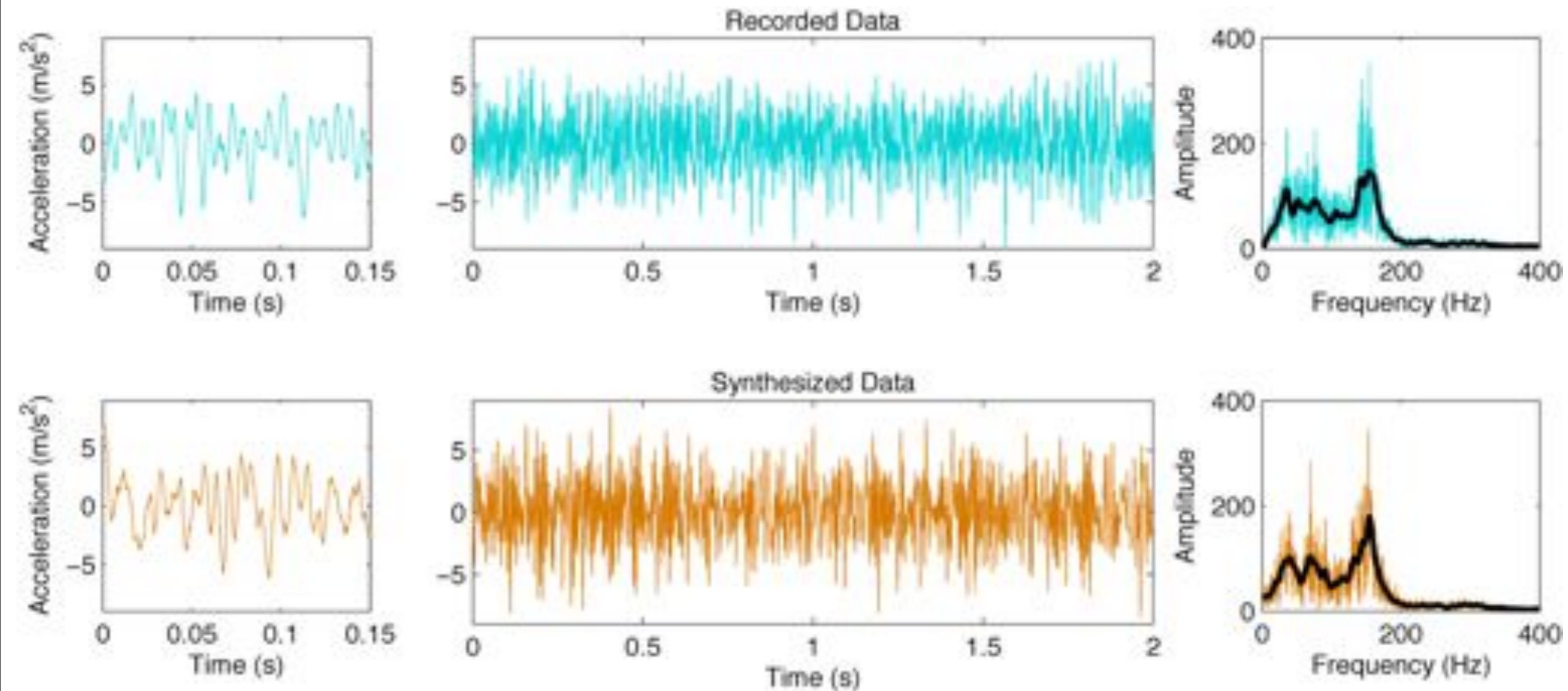

# Summary of Texture Rendering

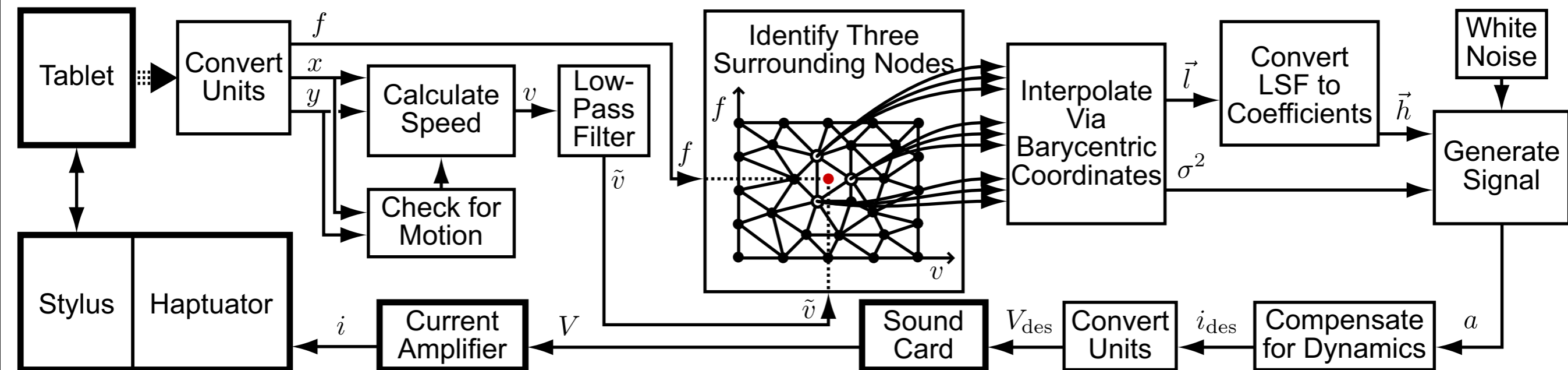

[13] Heather Culbertson, Juliette Unwin, and Katherine J. Kuchenbecker. Modeling and rendering realistic textures from unconstrained tool-surface interactions, 2014. Under revisions for *IEEE Transactions on Haptics*.

# Rendering Hardware

# Haptic Interface Motors are Far from the Hand



# Vibration Actuation Approach: Dedicated Actuator on Handle

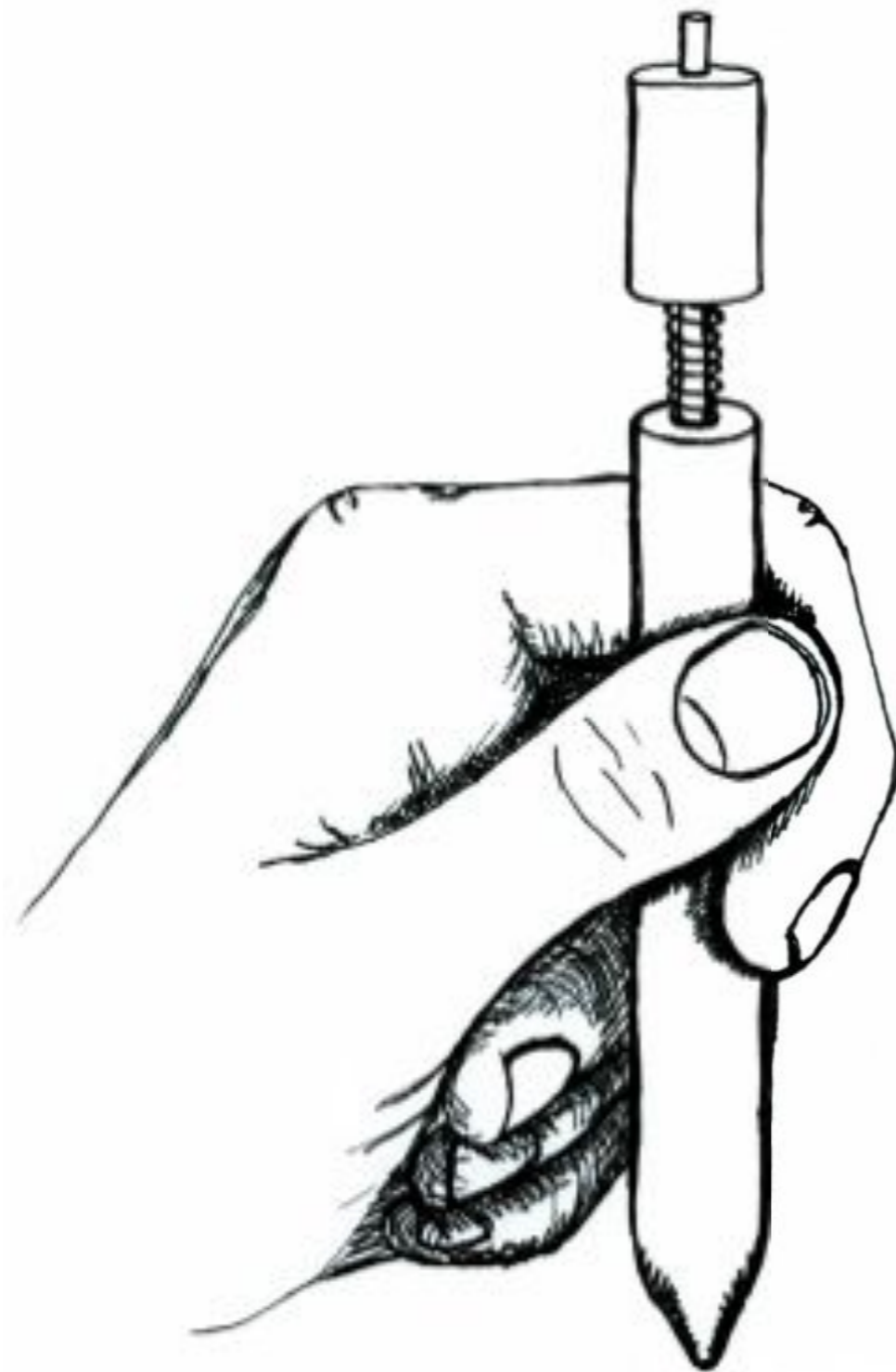

Voice-Coil  
Actuator

Suspension

Handle

User's  
Hand

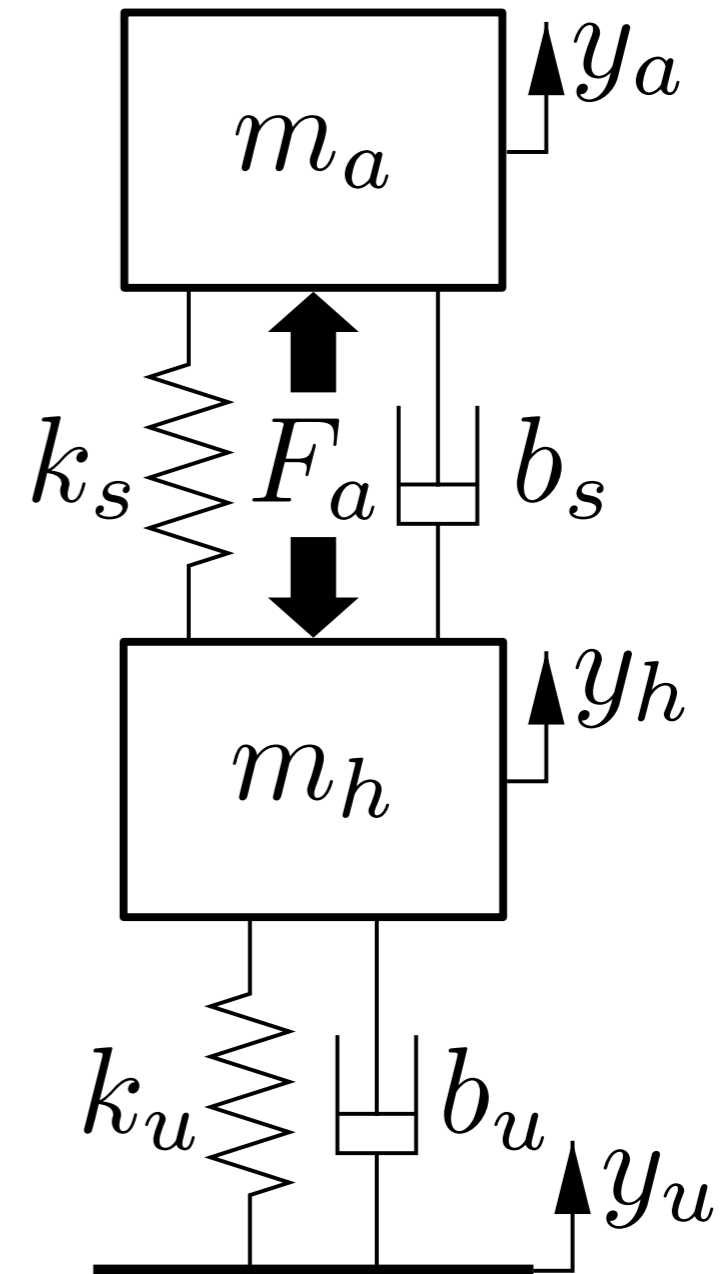

[3] William McMahan and Katherine J. Kuchenbecker. Haptic display of realistic tool contact via dynamically compensated control of a dedicated actuator. In *Proc. IEEE/RSJ International Conference on Intelligent Robots and Systems*, pp. 3171–3177. St. Louis, Missouri, USA, October 2009.

# Early Designs

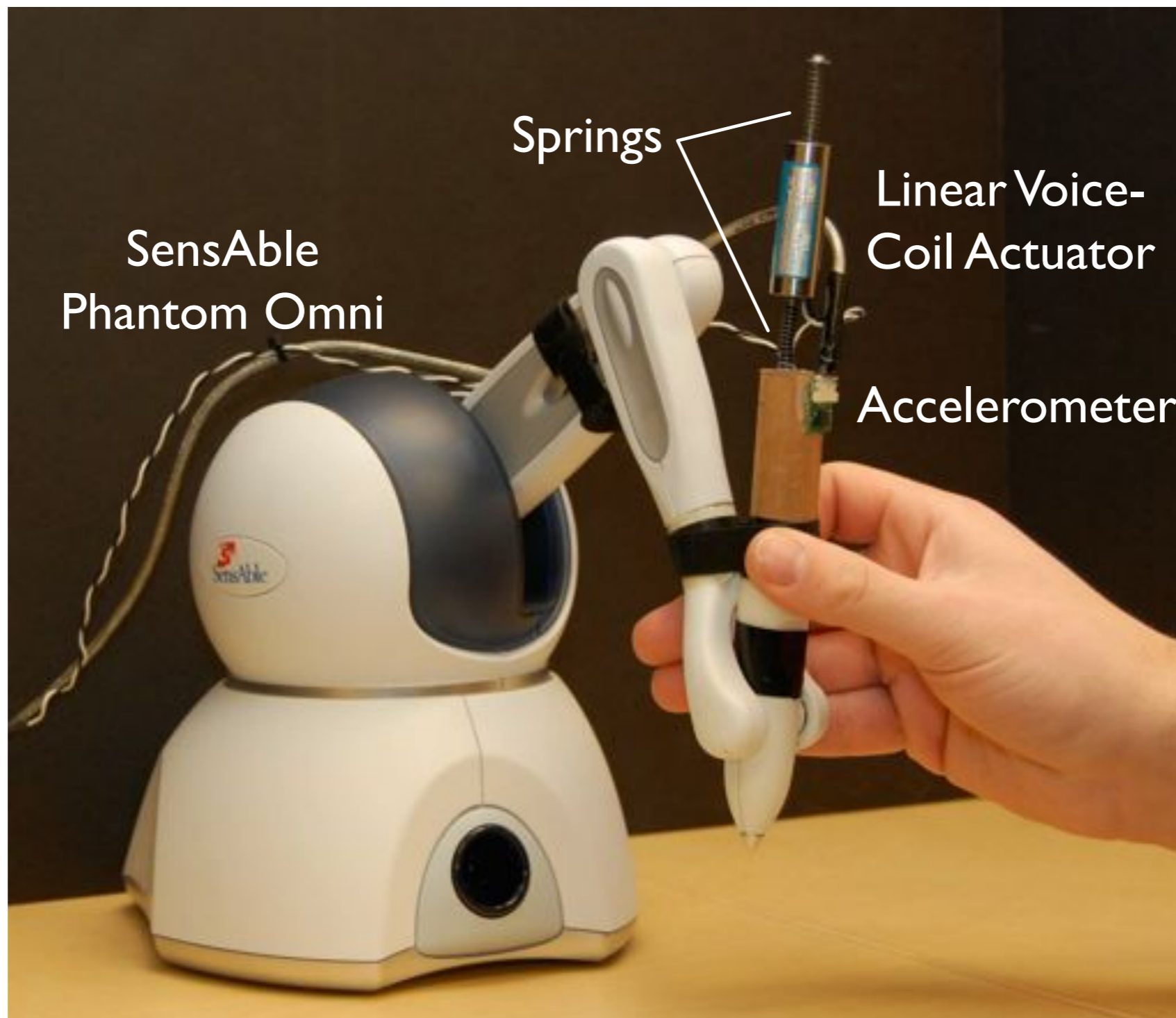

[3] William McMahan and Katherine J. Kuchenbecker. Haptic display of realistic tool contact via dynamically compensated control of a dedicated actuator. In *Proc. IEEE/RSJ International Conference on Intelligent Robots and Systems*, pp. 3171–3177. St. Louis, Missouri, USA, October 2009.



# Early Designs

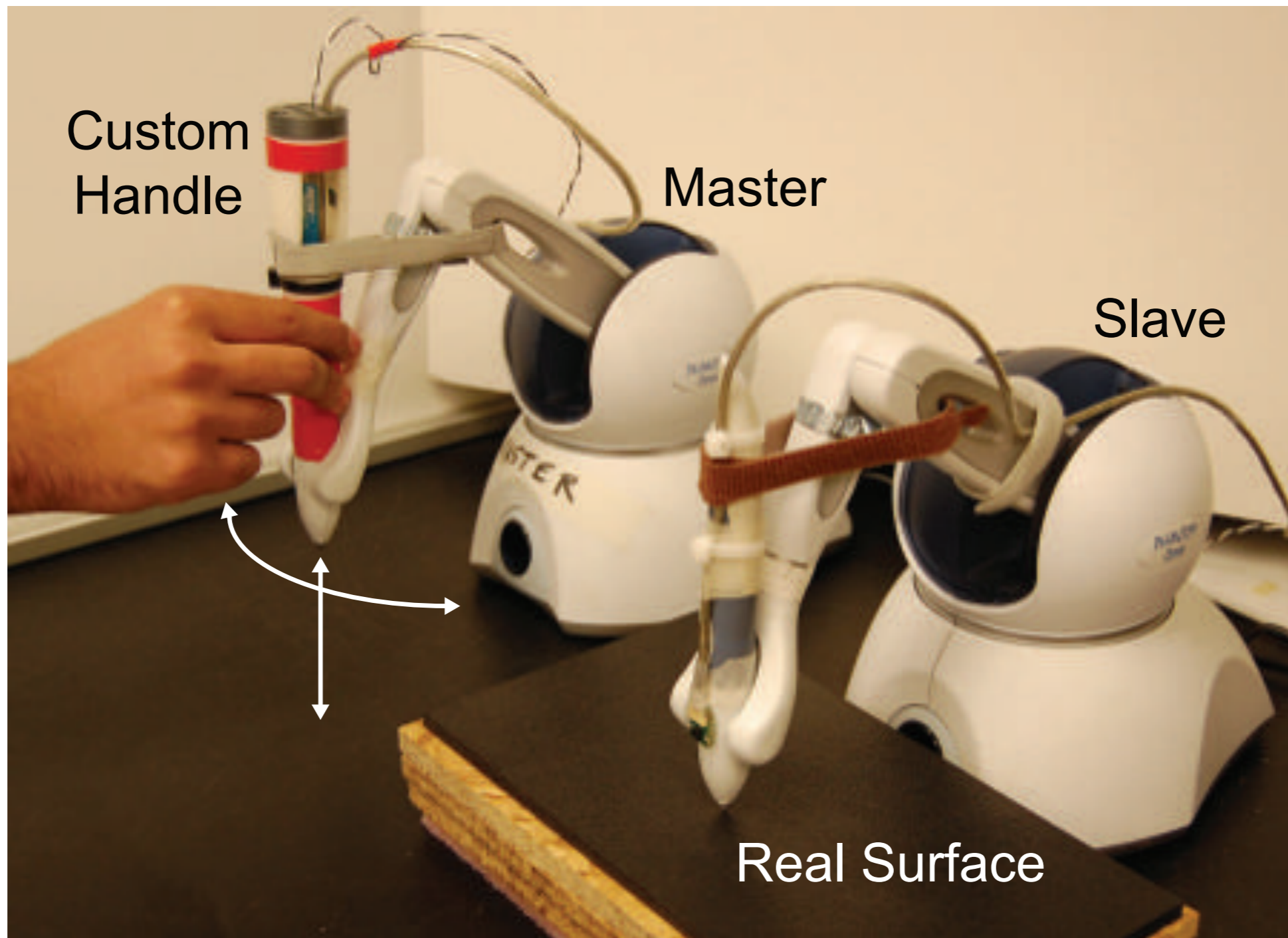

[4] William McMahan, Joseph M. Romano, Amal M. Abdul Rahuman, and Katherine J. Kuchenbecker. High frequency acceleration feedback significantly increases the realism of haptically rendered textured surfaces. In *Proc. IEEE Haptics Symposium*, pp. 141–148. Waltham, Massachusetts, March 2010.

# Early Designs

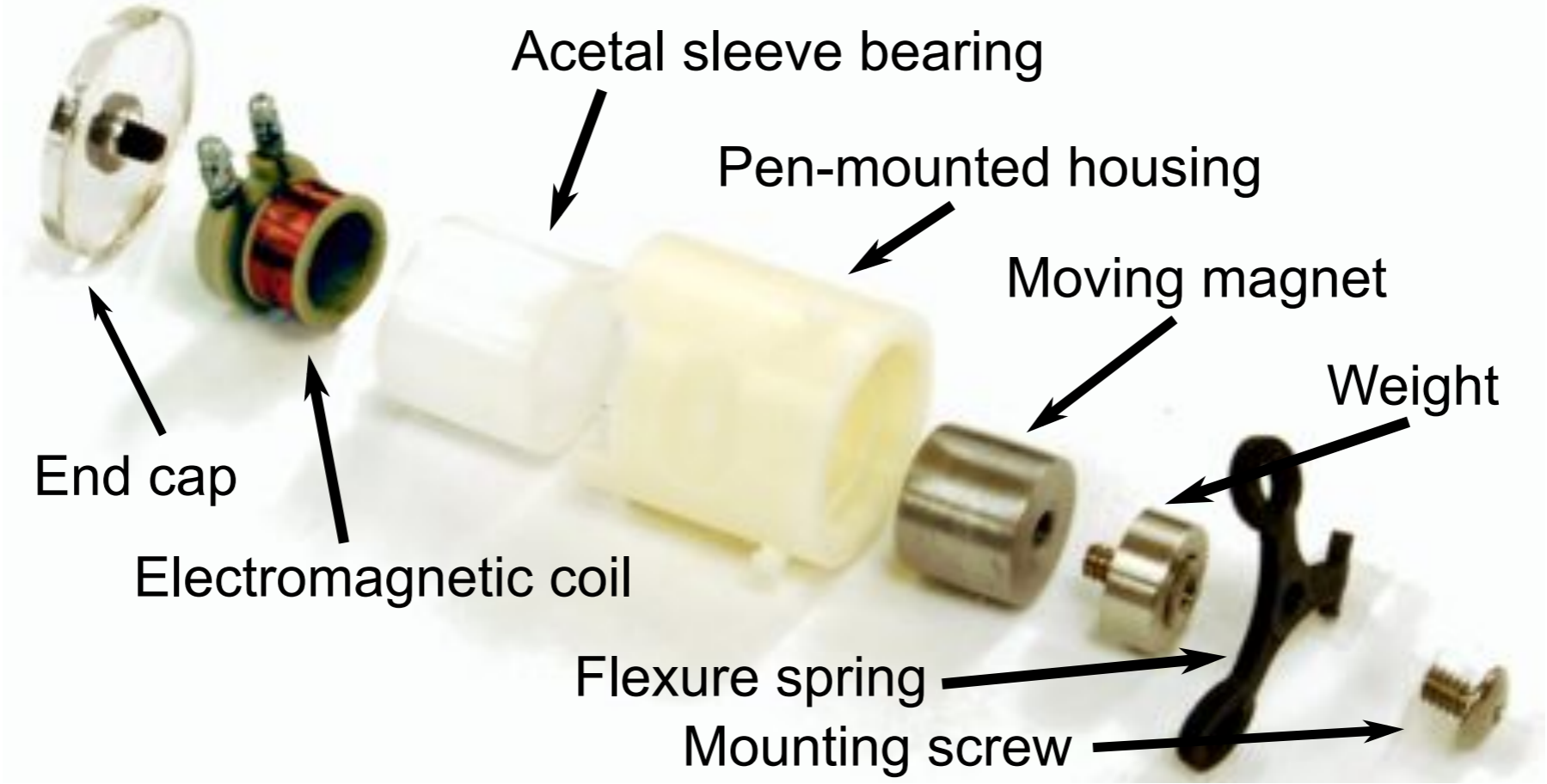
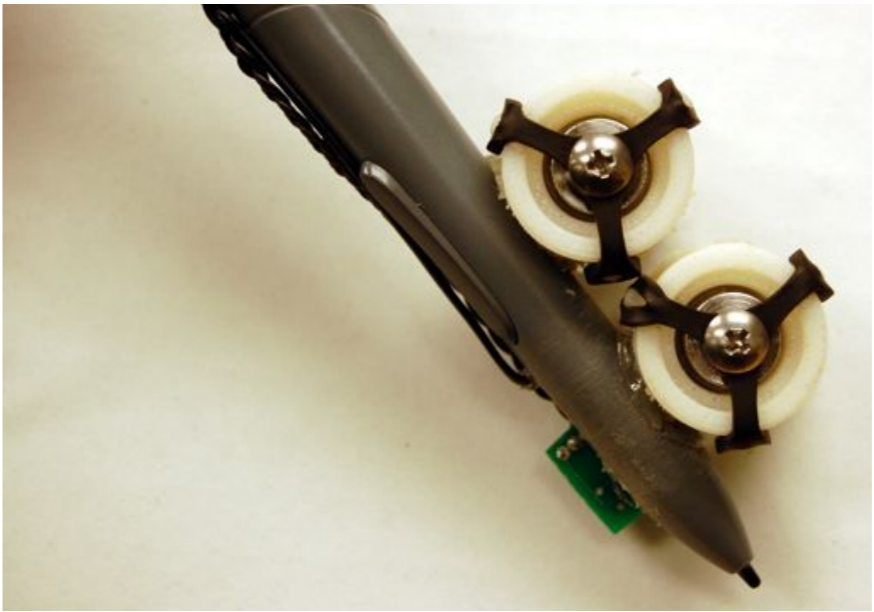
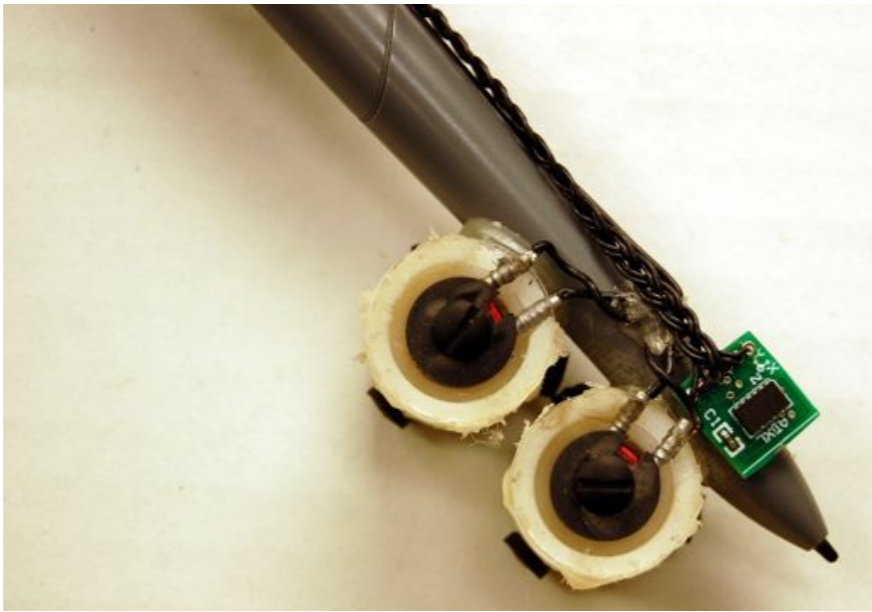

[8] Joseph M. Romano and Katherine J. Kuchenbecker. Creating realistic virtual textures from contact acceleration data. *IEEE Transactions on Haptics*, volume 5(2):pp. 109–119, April-June 2012.

# Haptuator by Tactile Labs \$170

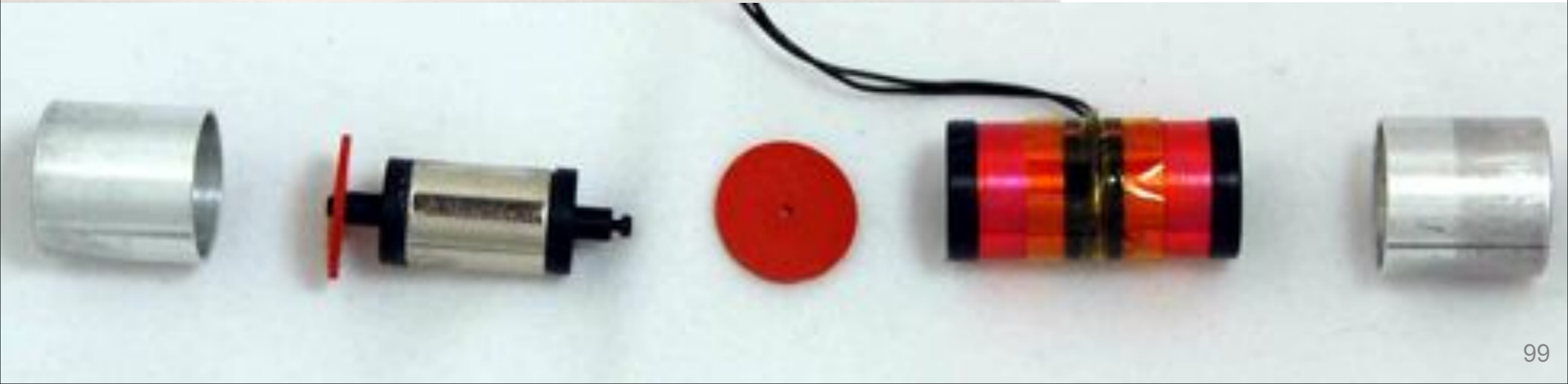

# Bracket Rigidly Attaches Haptuator to Handle



# Characterization of Actuator Dynamics

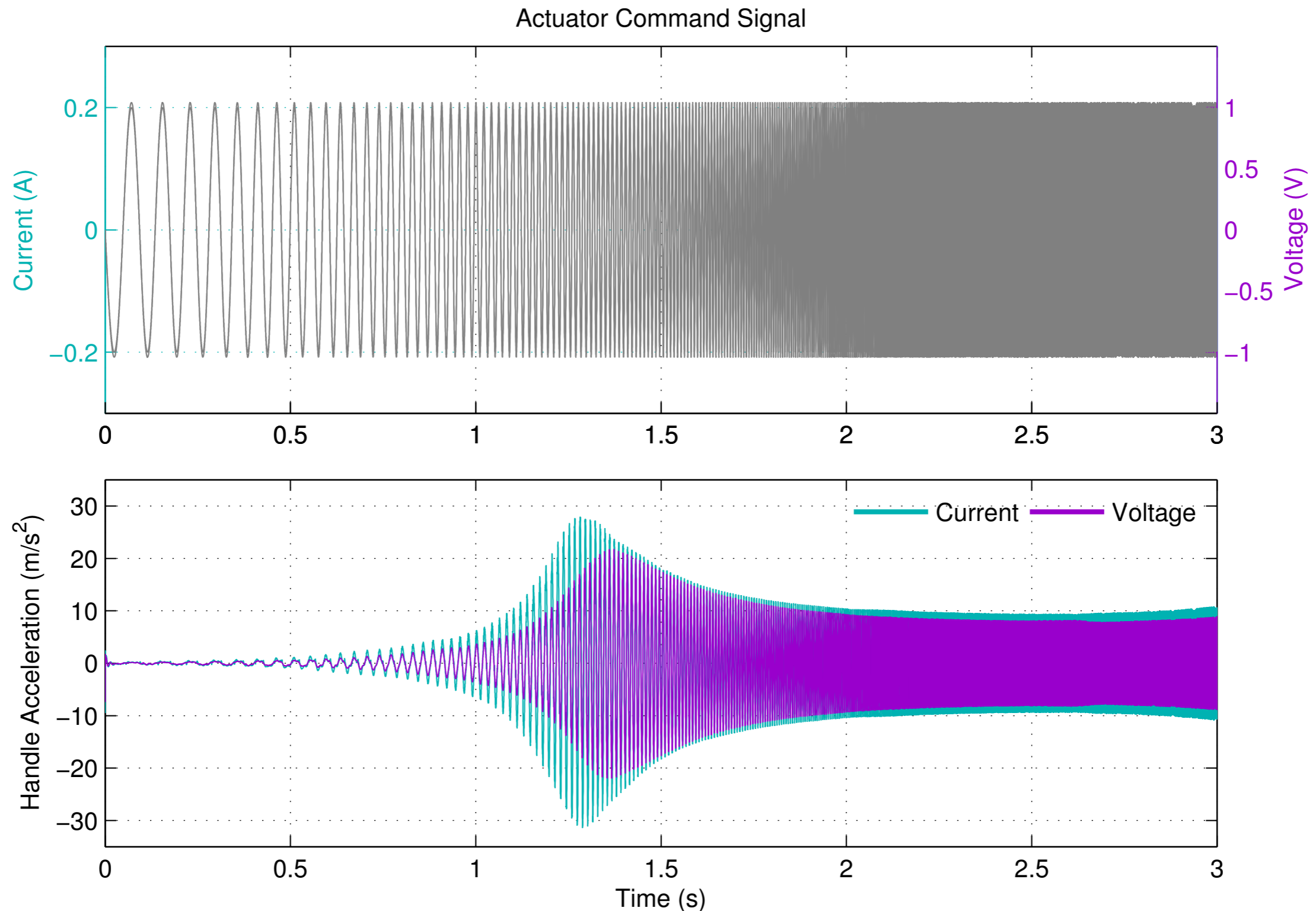

[12] William McMahan and Katherine J. Kuchenbecker. Dynamic modeling and control of voice-coil actuators for high-fidelity display of haptic vibrations. In *Proc. IEEE Haptics Symposium*. February 2014. **O3-5**

# Empirical Transfer Function Estimates: Strong Resonance

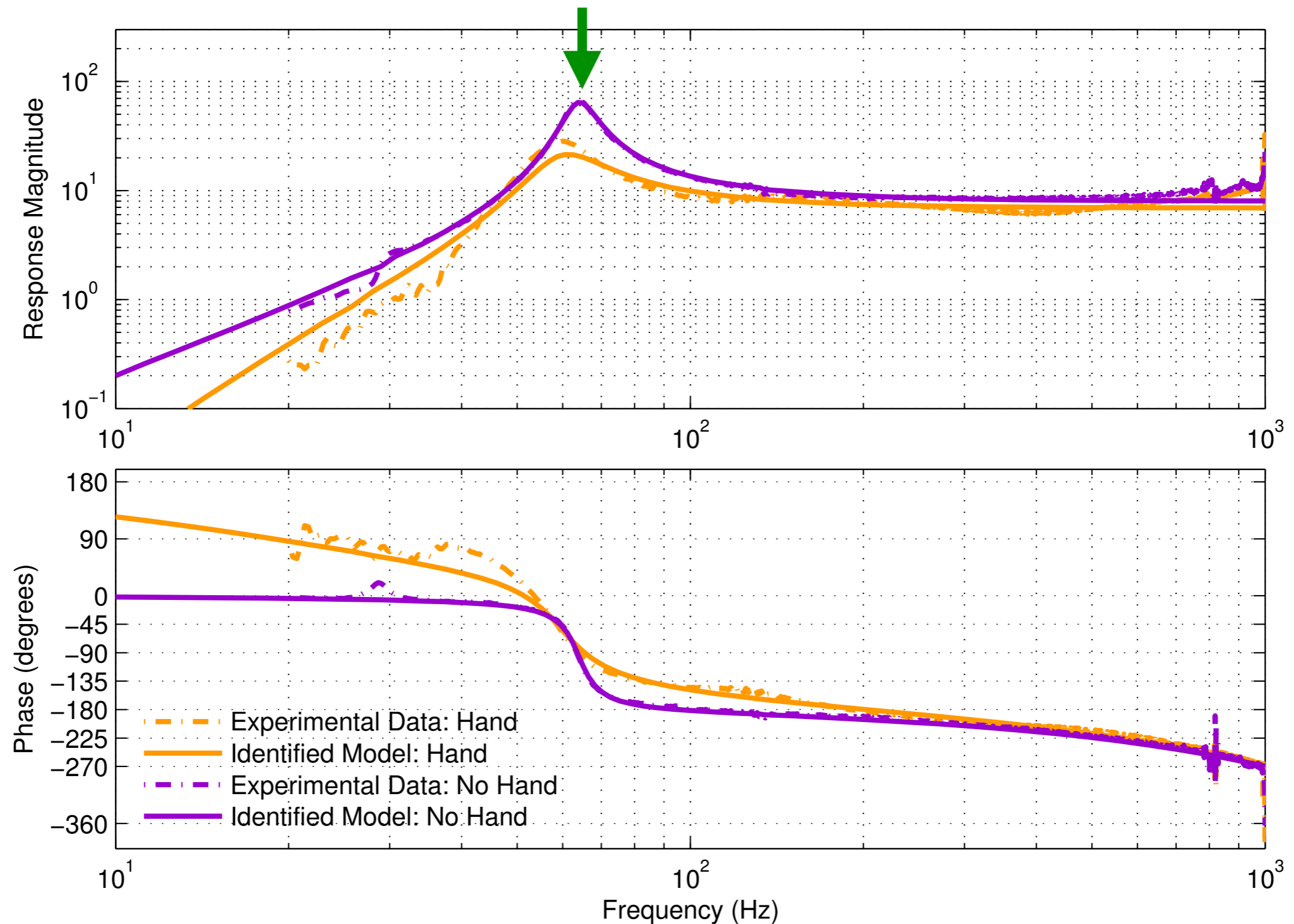

[12] William McMahan and Katherine J. Kuchenbecker. Dynamic modeling and control of voice-coil actuators for high-fidelity display of haptic vibrations. In *Proc. IEEE Haptics Symposium*. February 2014. **O3-5**

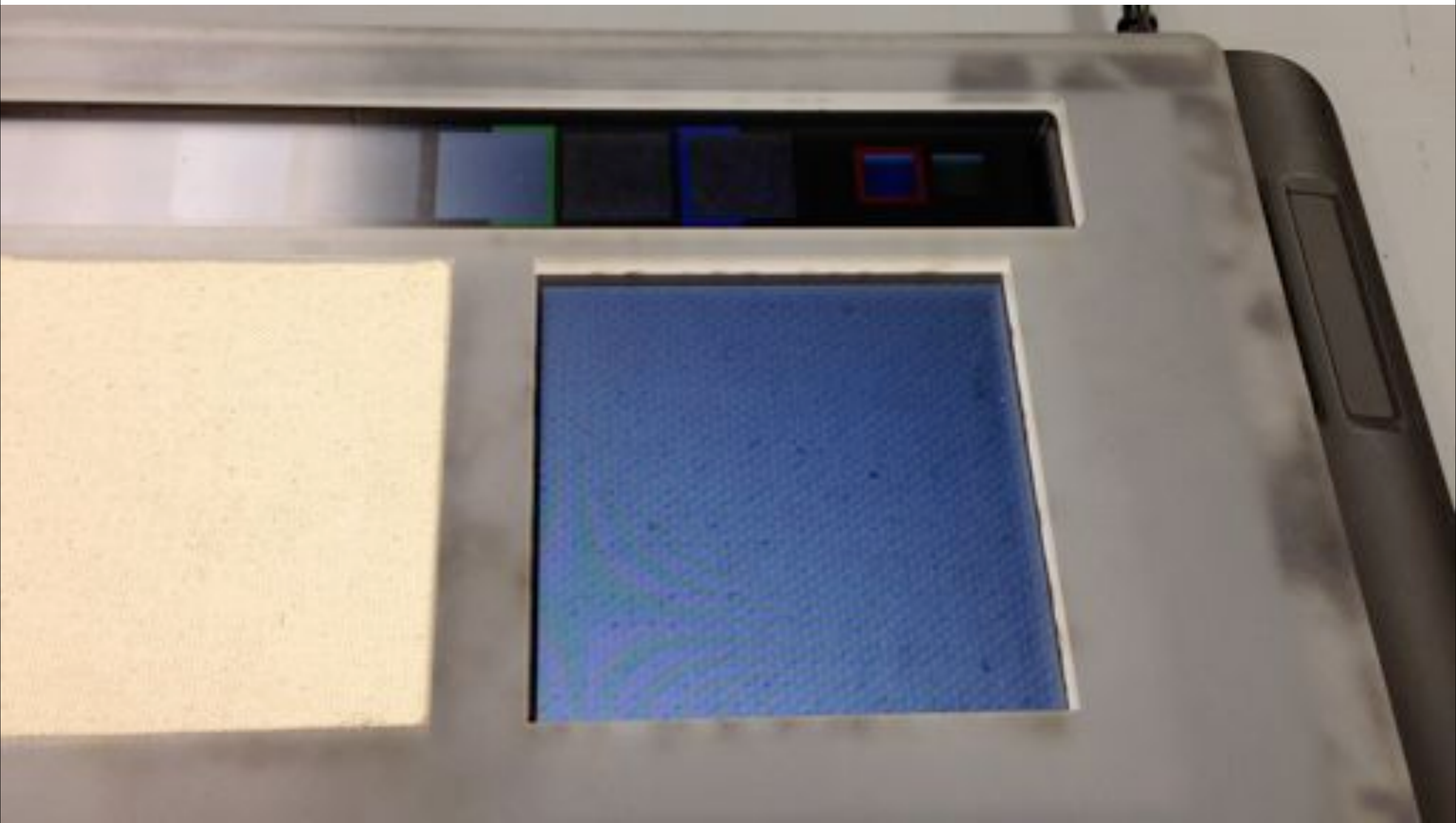

# Vibration gain significantly affects perceived realism. ( $F(3,215) = 242, p < 0.001, \eta^2 = 0.705$ )

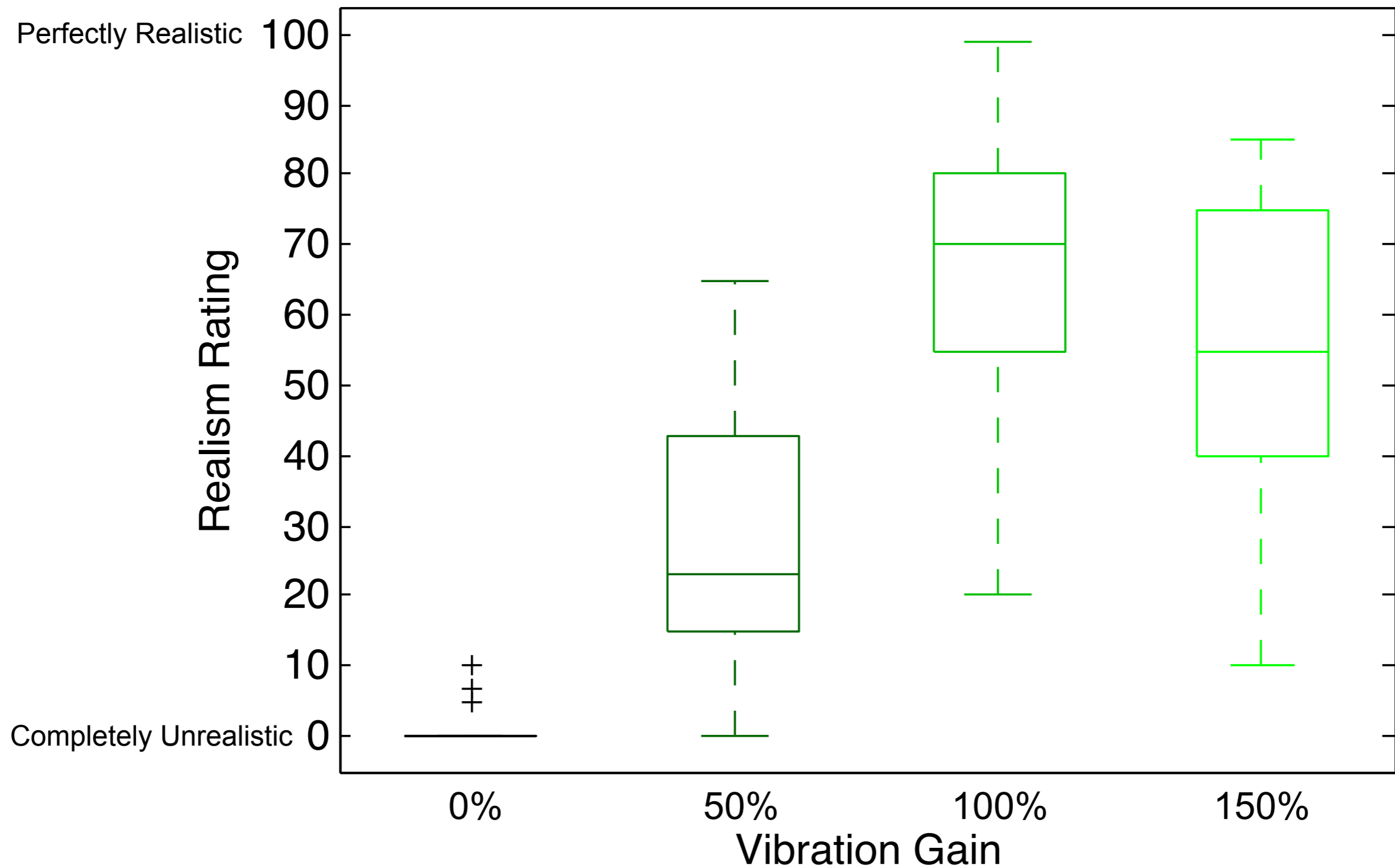

[8] Joseph M. Romano and Katherine J. Kuchenbecker. Creating realistic virtual textures from contact acceleration data. *IEEE Transactions on Haptics*, volume 5(2):pp. 109–119, April-June 2012.



# Demonstration 2: TexturePad



# Demonstration 2: TexturePad

What questions do you have?

# Perception of Virtual Textures

# Aims of study

- Evaluate texture modeling and rendering
- Assess similarities of real and virtual textures
- Evaluate how perceptual qualities translate to virtual textures

# Study procedure

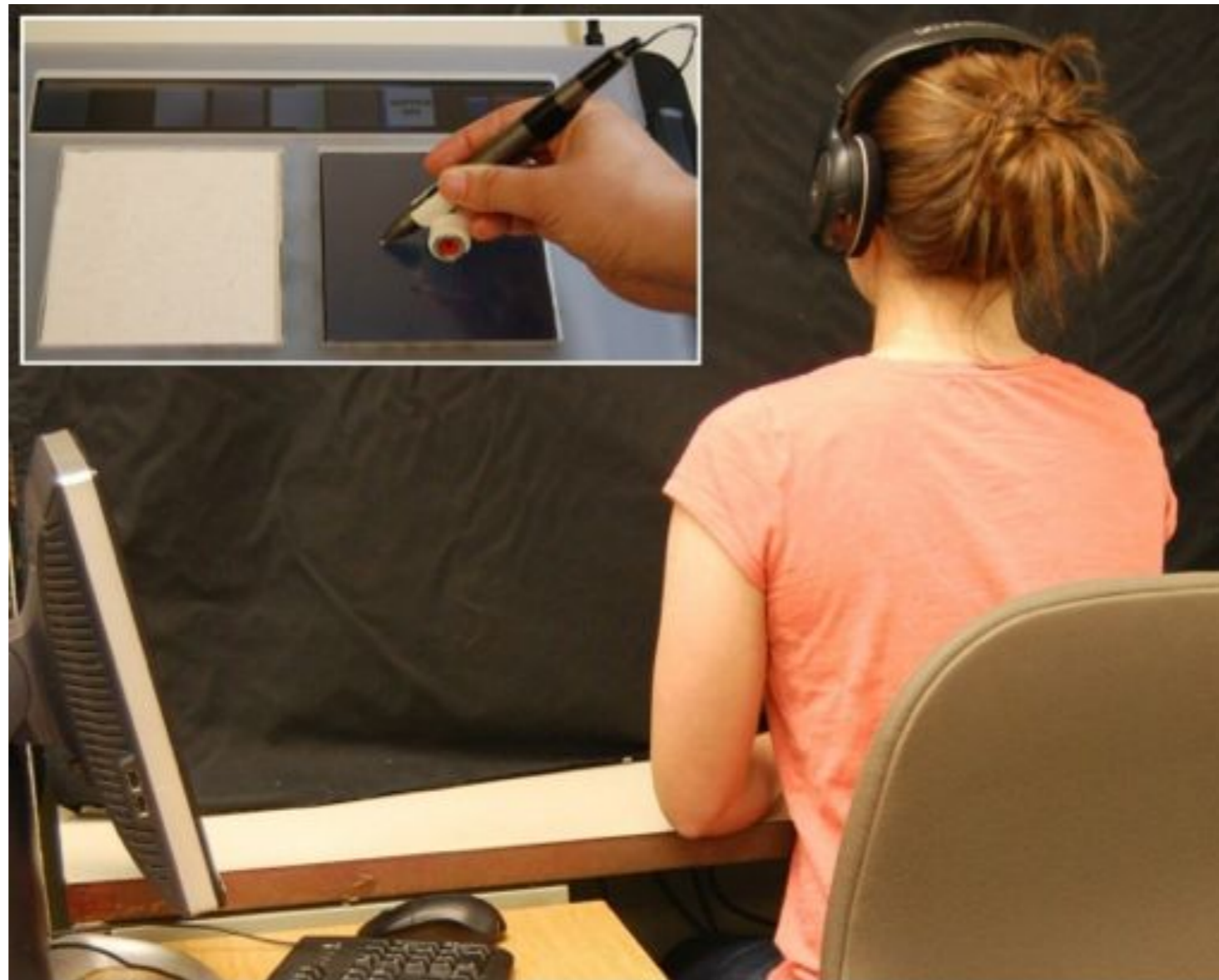

# Phase 1: Free Exploration

- Ten textures presented one at a time
- First 10 seconds of interaction data were recorded

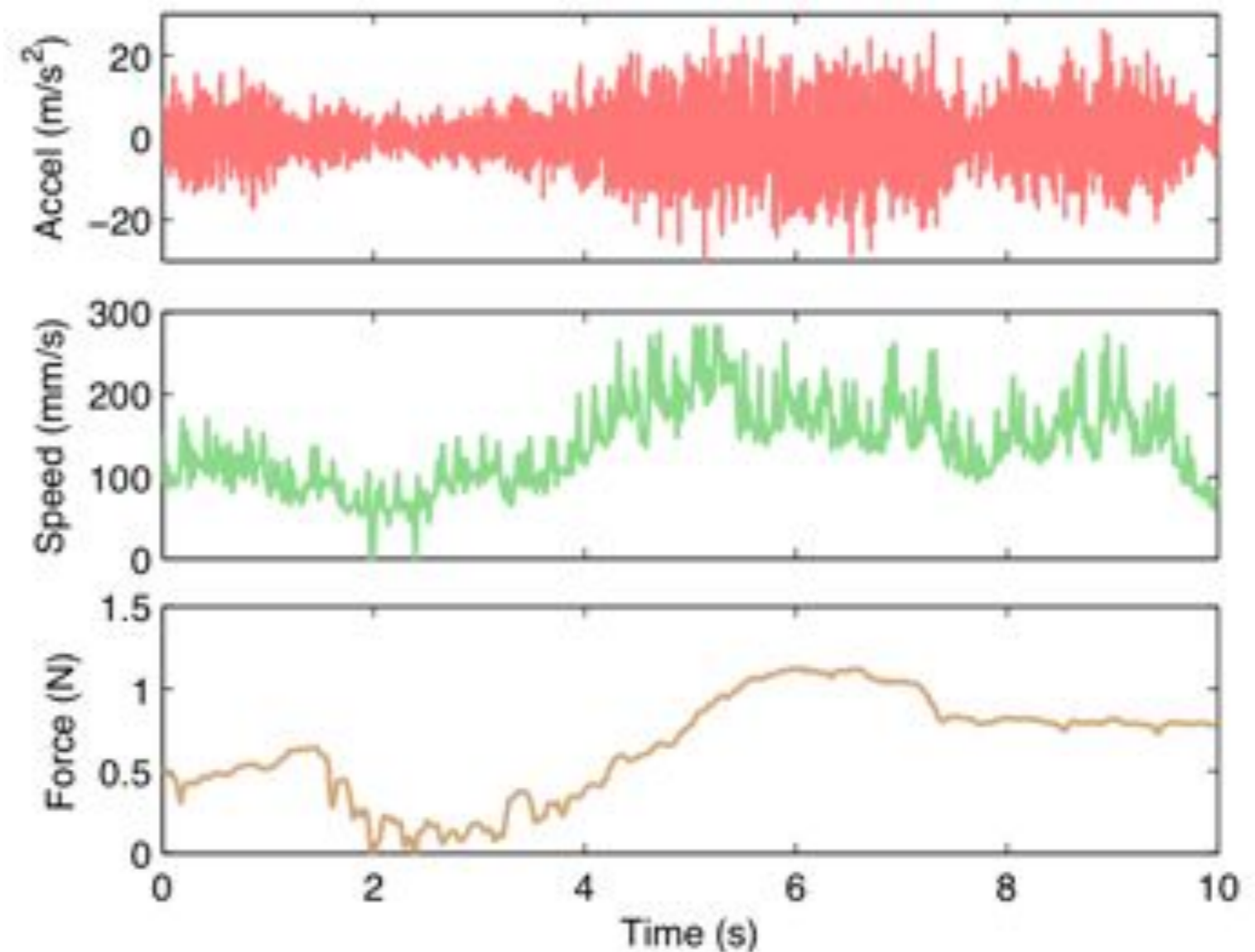

# Phase 2: Pairwise comparison

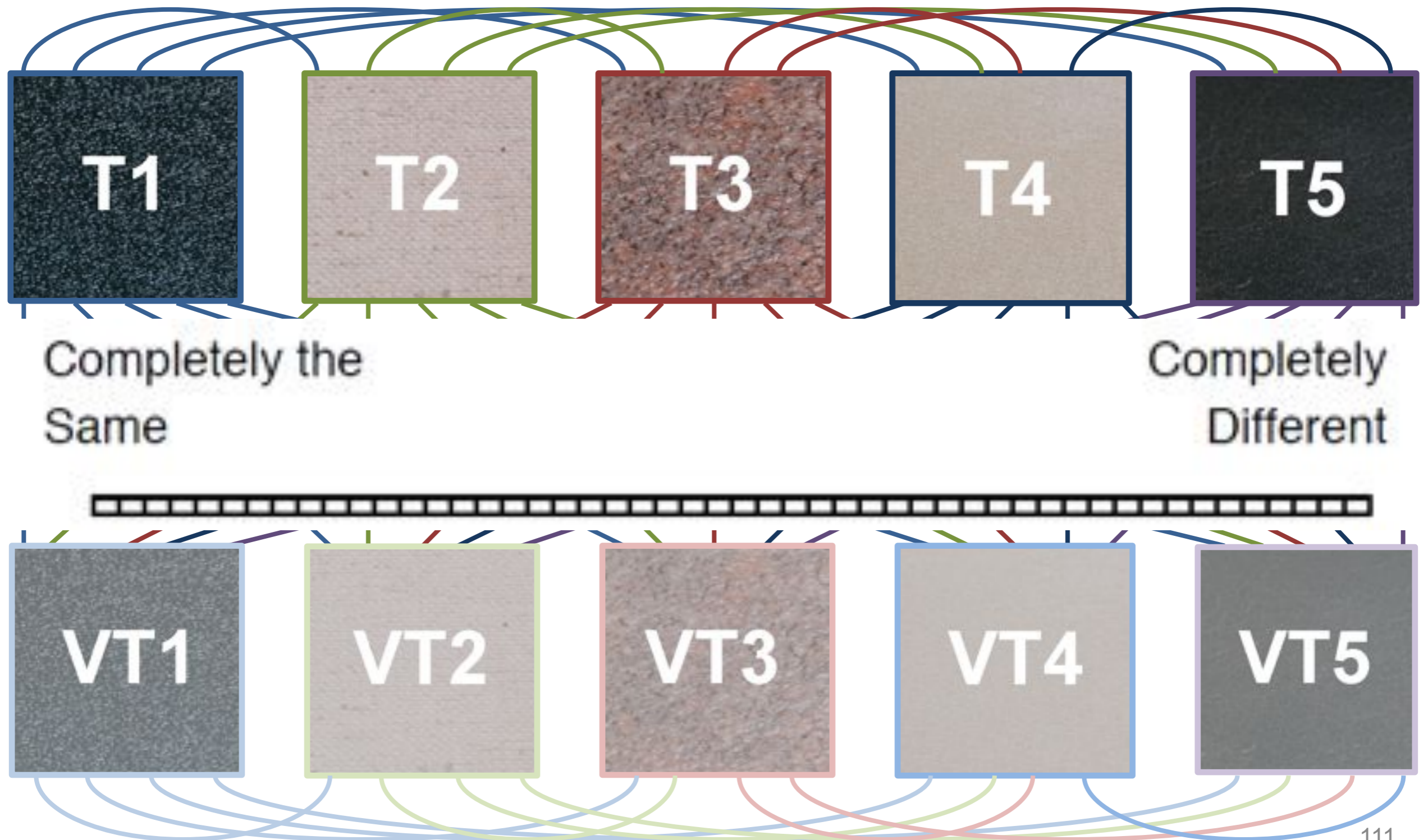

# Phase 3: Adjective Rating Scales

Rough

Smooth

Hard

Soft

Slippery

Not Slippery

Fine

Coarse

*(Place a mark on the scale above)*



# Results: Free Exploration

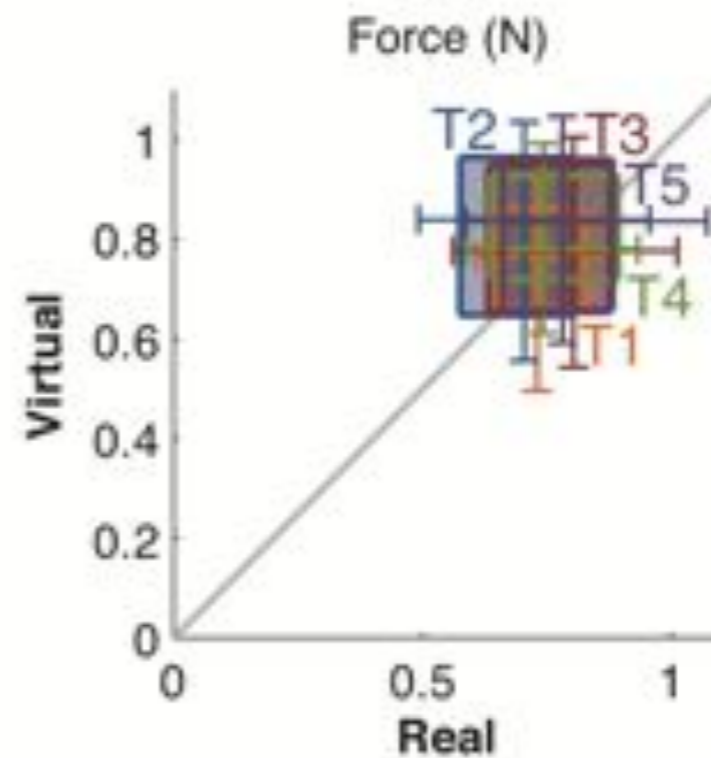
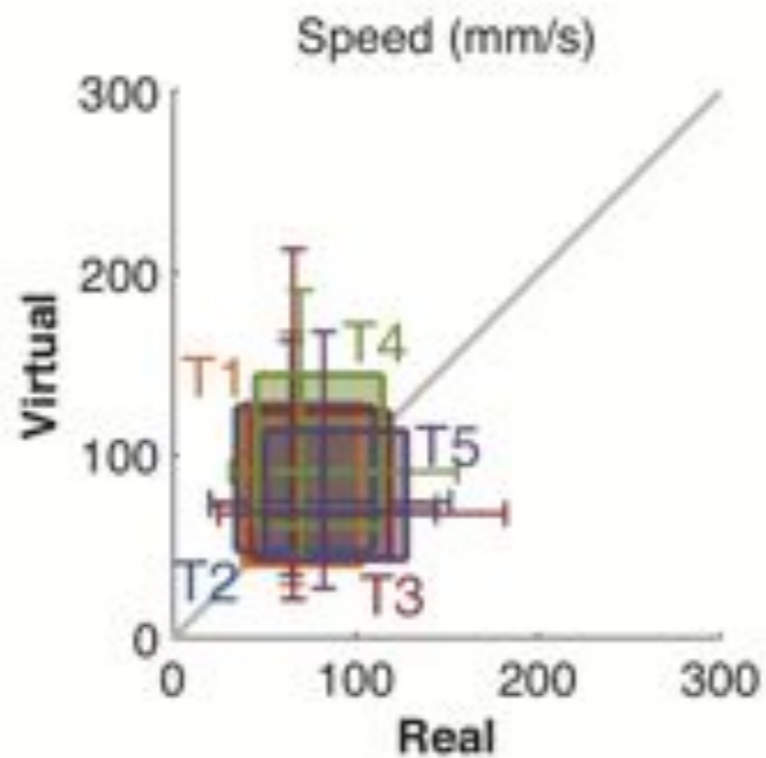
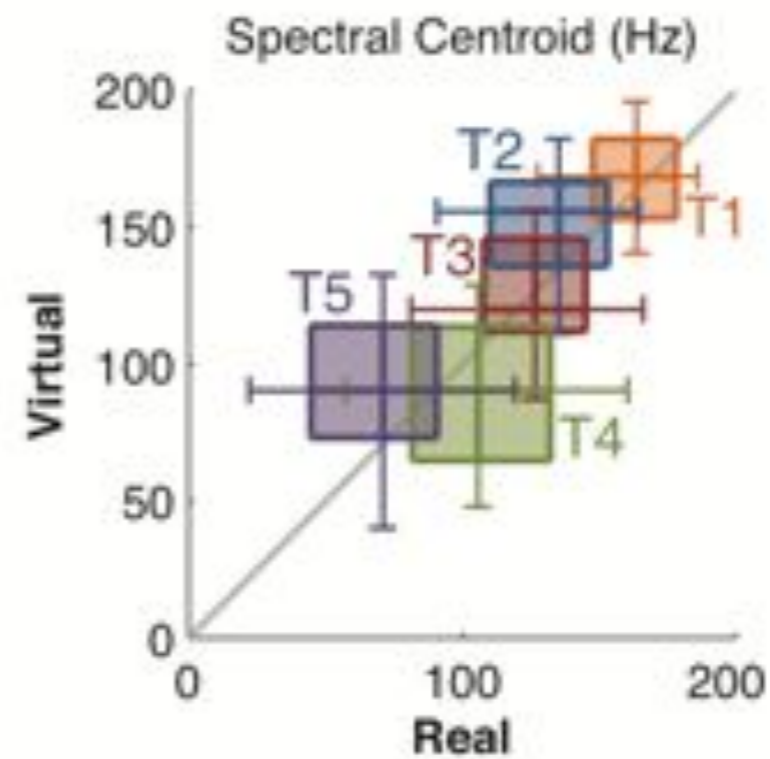
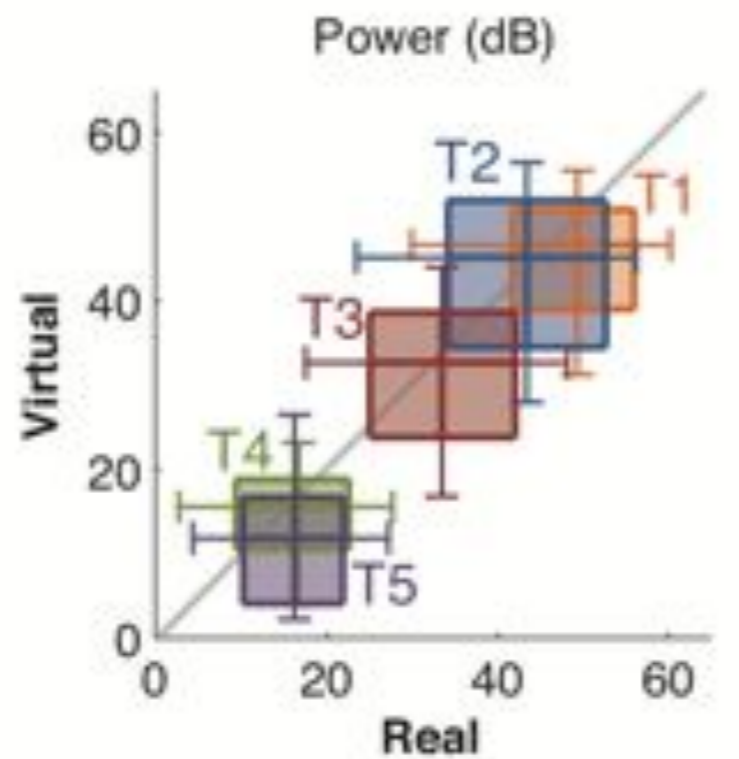

# Results: Dissimilarity Ratings

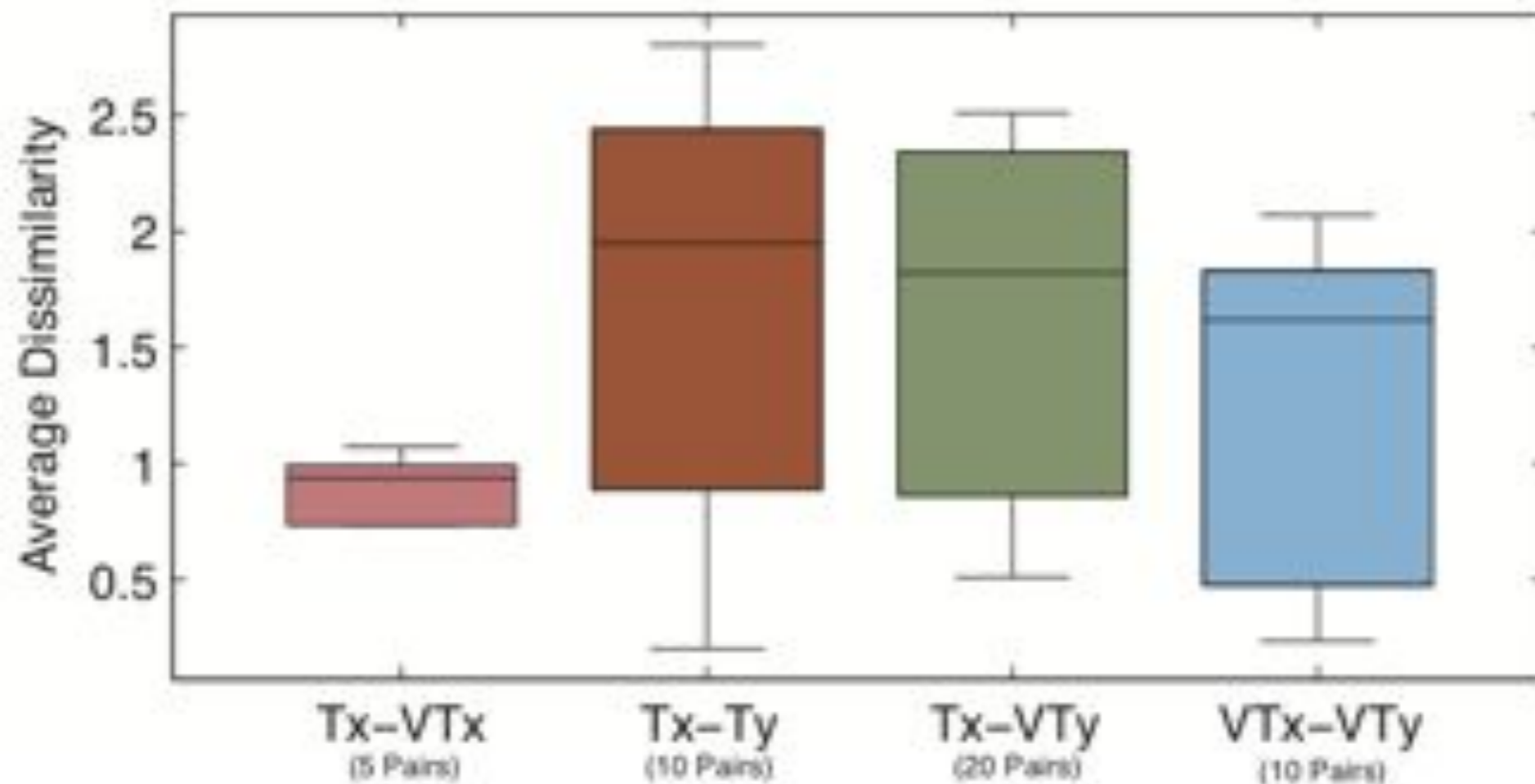

# Results: Multi-dimensional Scaling and Clustering

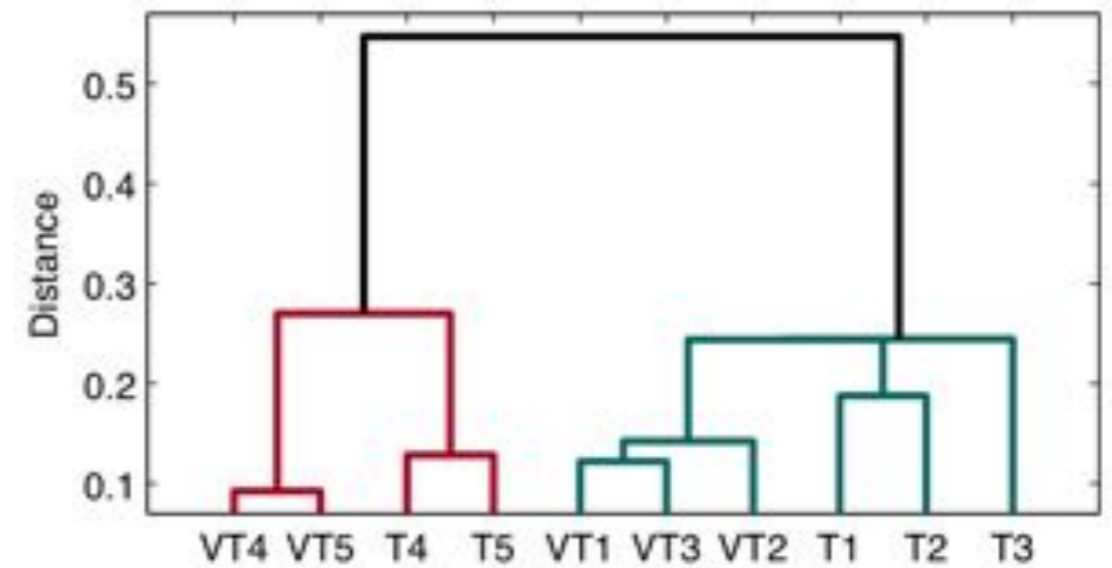
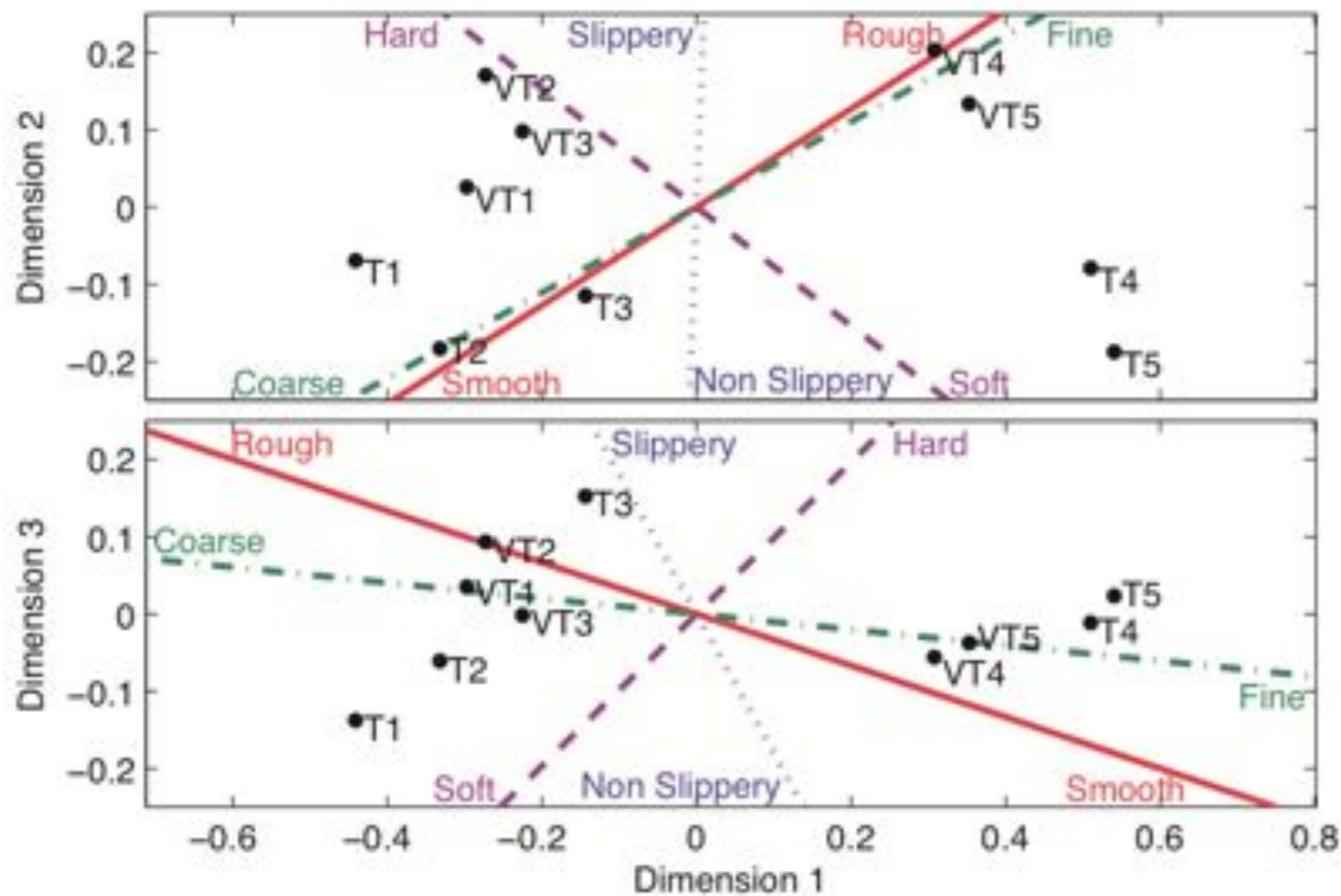

# Results: Predicted Dissimilarity

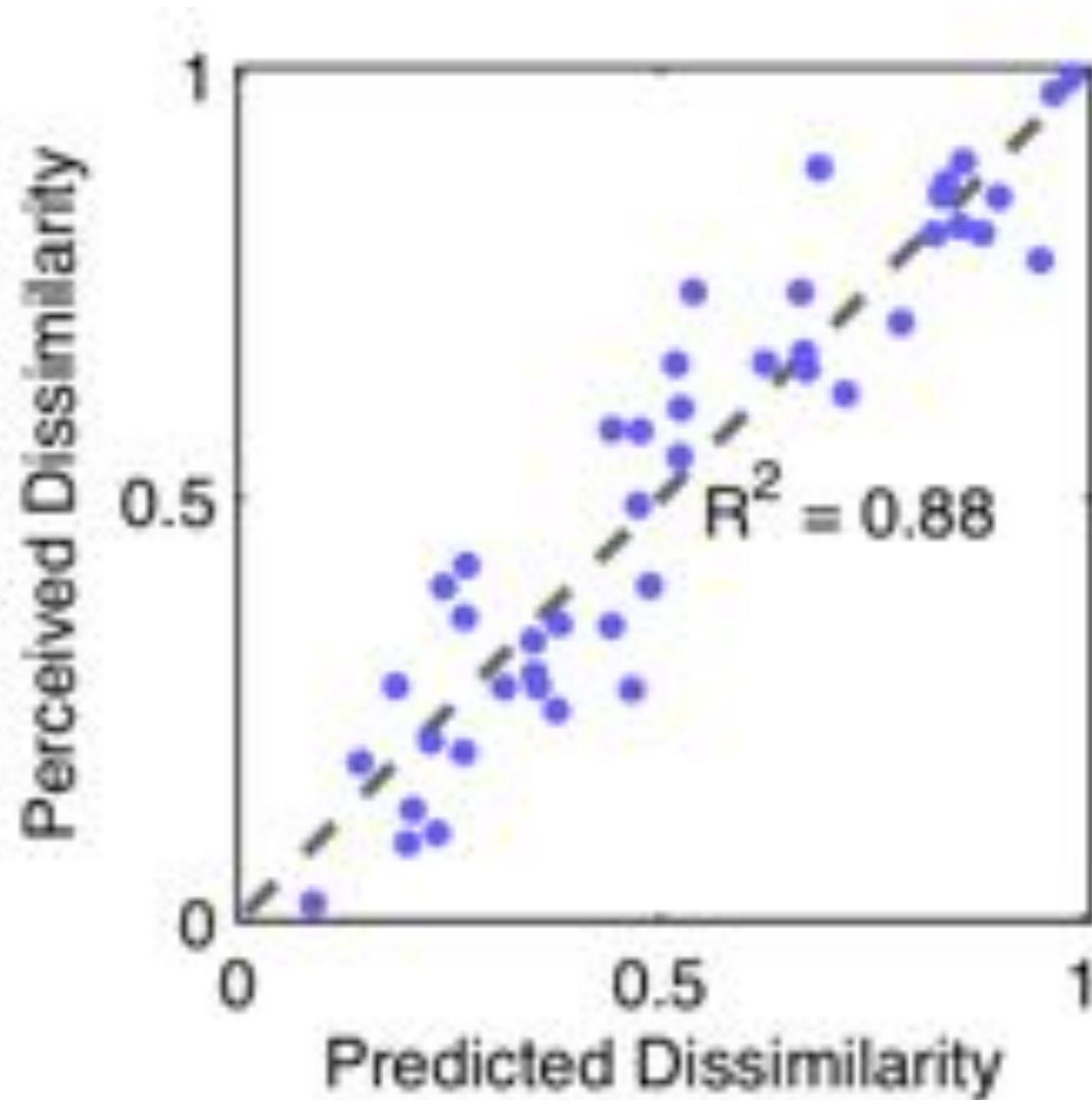

# Results: Adjective Ratings

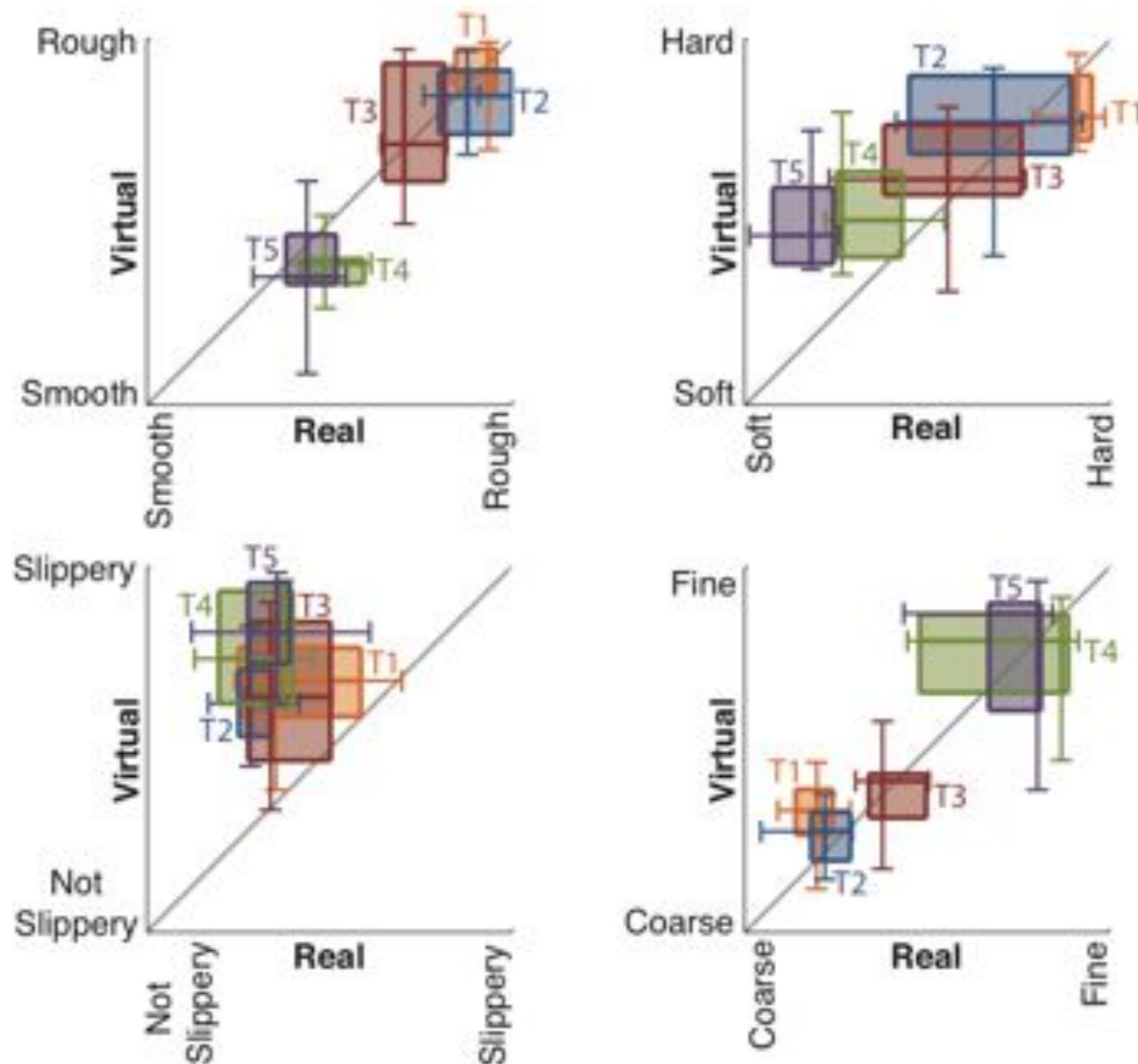

# Discussion

- Surface roughness was accurately captured
- Roughness and fineness ratings were highly correlated
  - Both physical roughness and fineness contribute to perceived roughness
- Future modeling and rendering considerations
  - To fully capture hardness, surface stiffness must be rendered separately
  - Slipperiness (friction) should be rendered directly

# The Penn Haptic Texture Toolkit

# Modeled Surfaces

Paper

Metal

Carbon Fiber

Fabric

Plastic

Wood

Stone

Foam

Tile

Carpet

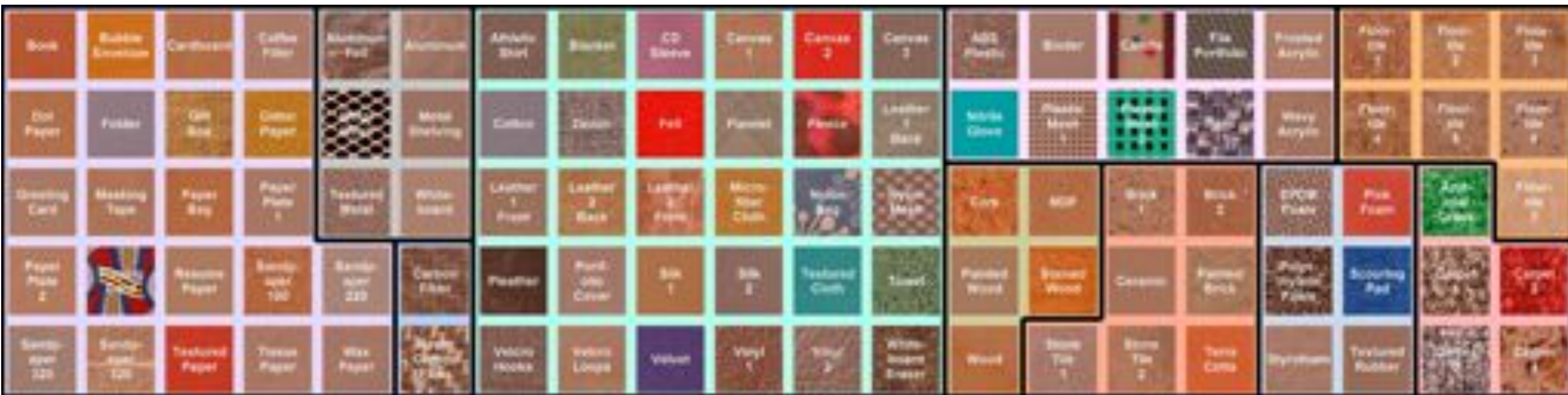

[11] Heather Culbertson, Juan José López Delgado, and Katherine J. Kuchenbecker. One hundred data-driven haptic texture models and open-source methods for rendering on 3D objects. In *Proc. IEEE Haptics Symposium*. February 2014. **Poster 11 & Demo 11**



# Recorded Data

- Two recorded data files for each texture
  - 10 seconds each
- Data used to create texture and friction models
- Sampling Rate
  - 10 kHz
- All axes are with respect to the world frame
- Stored in XML format

# Acceleration Data

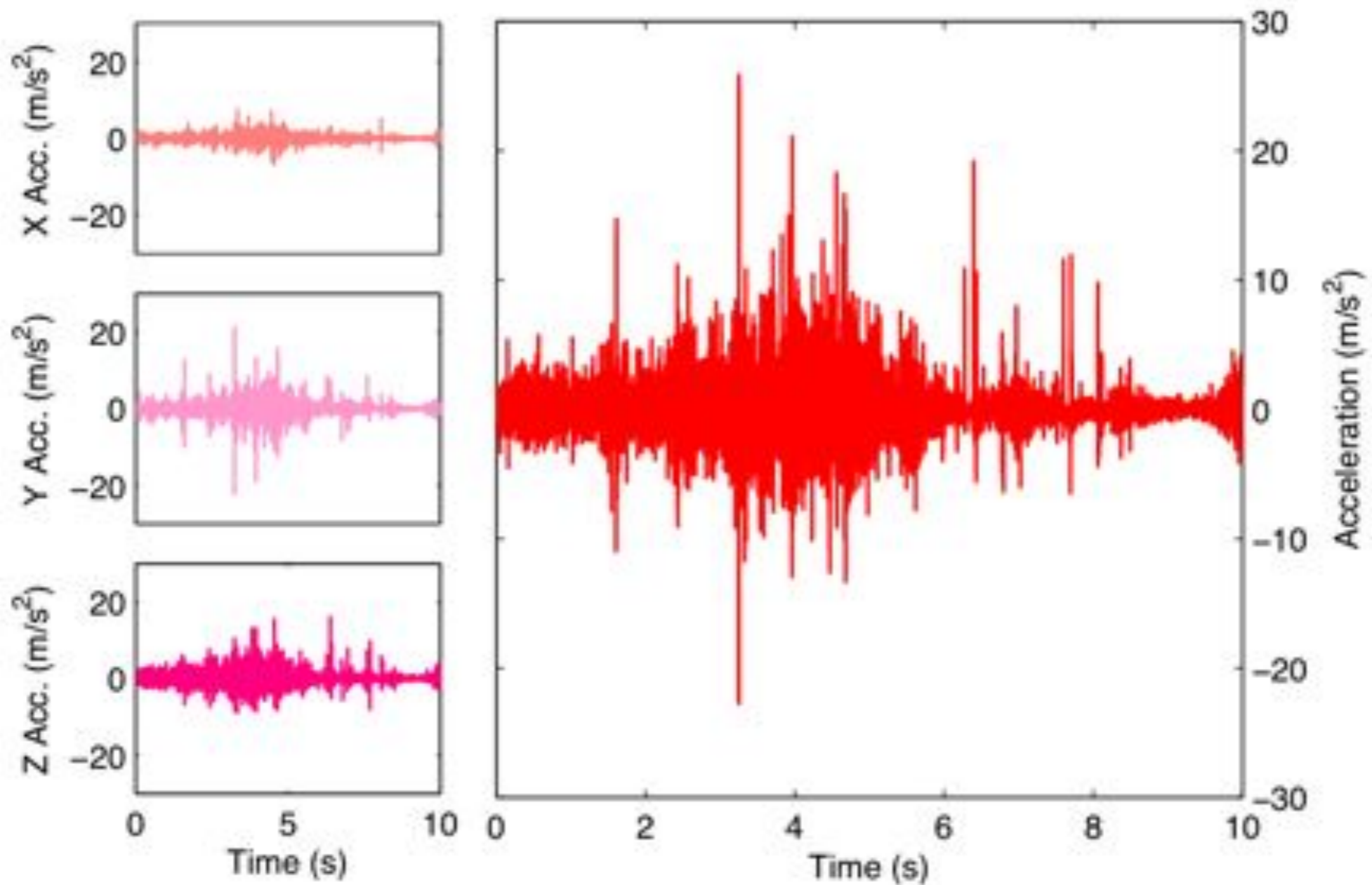

# Position Data

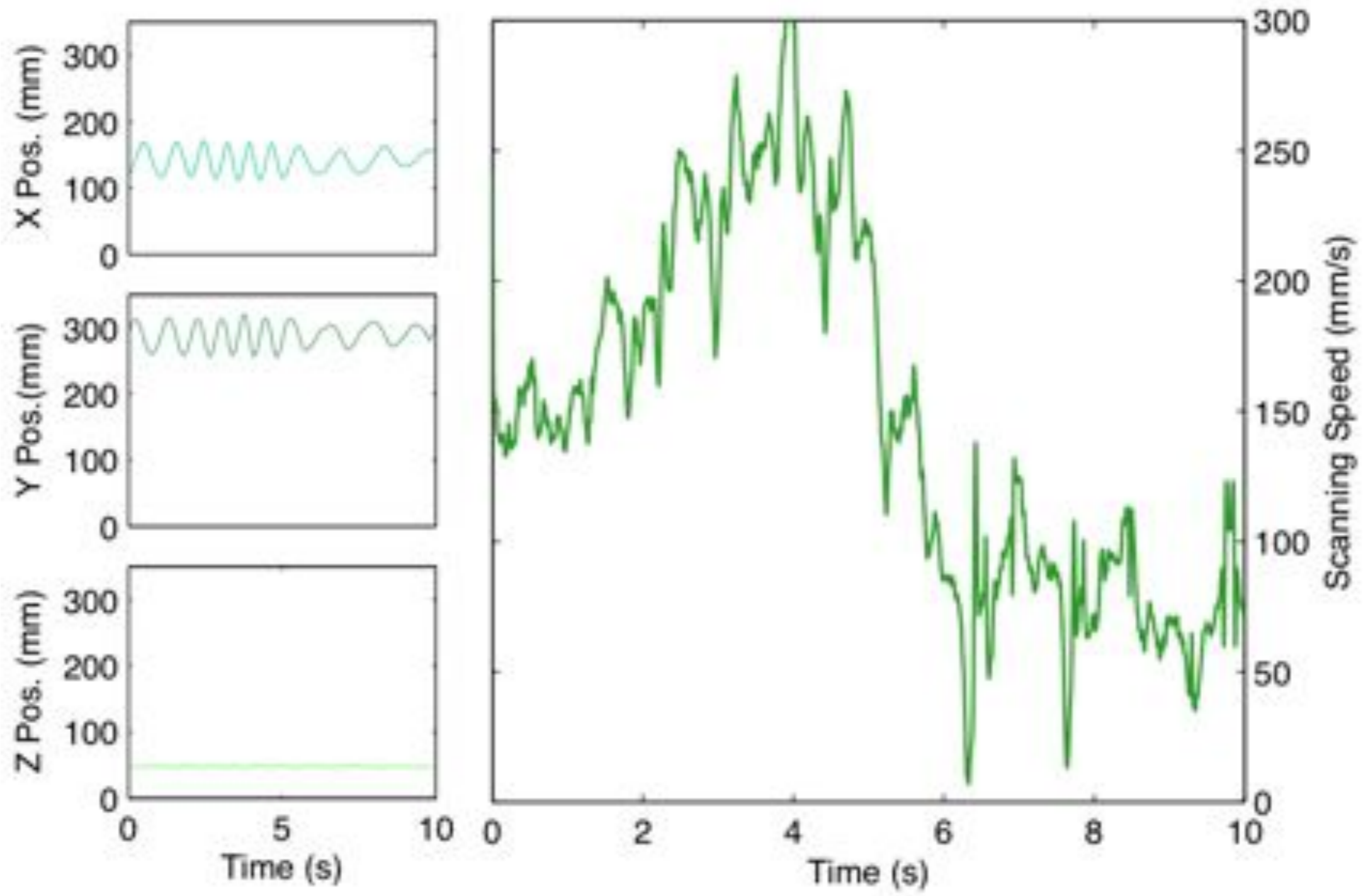

# Force Data

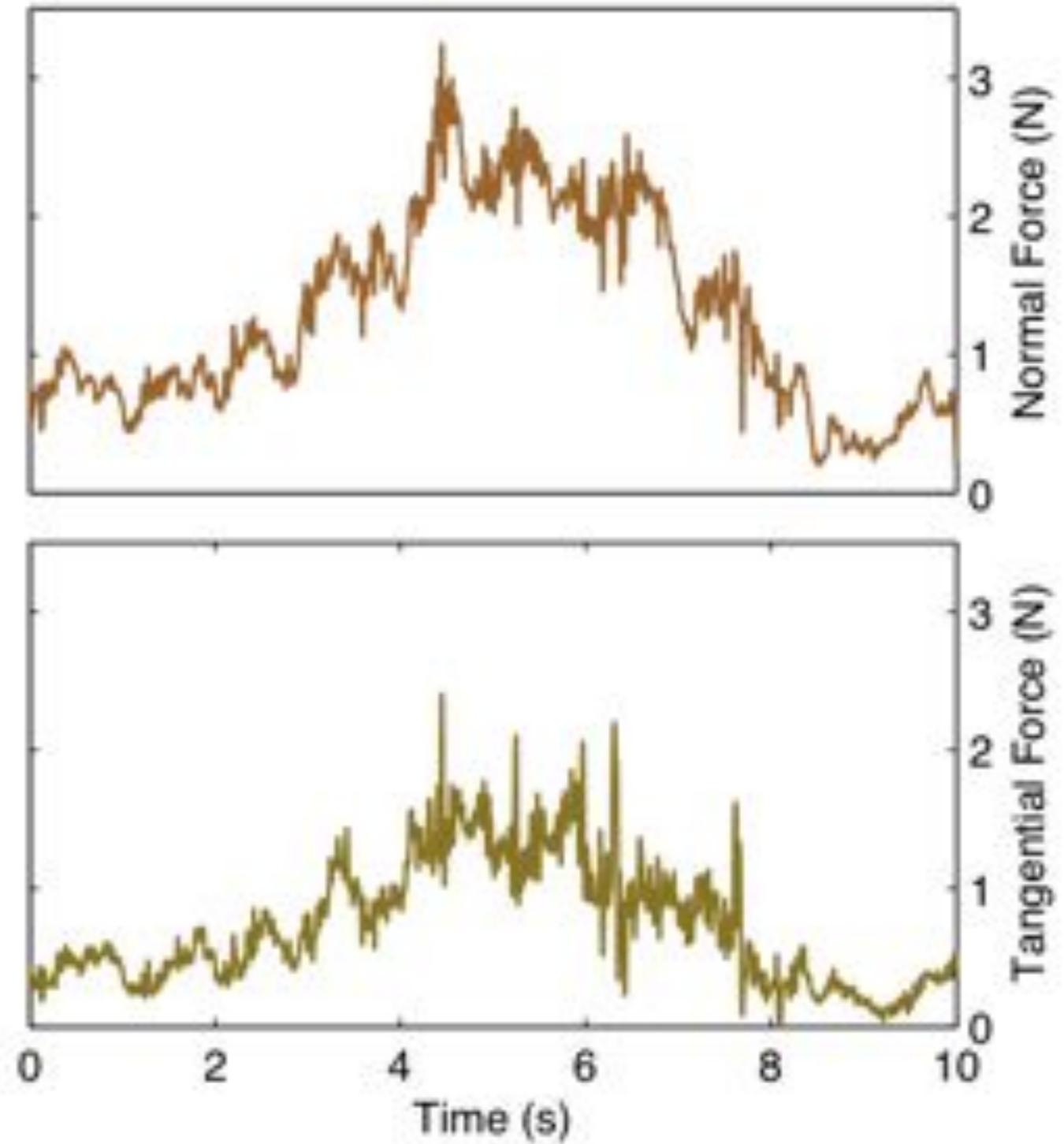
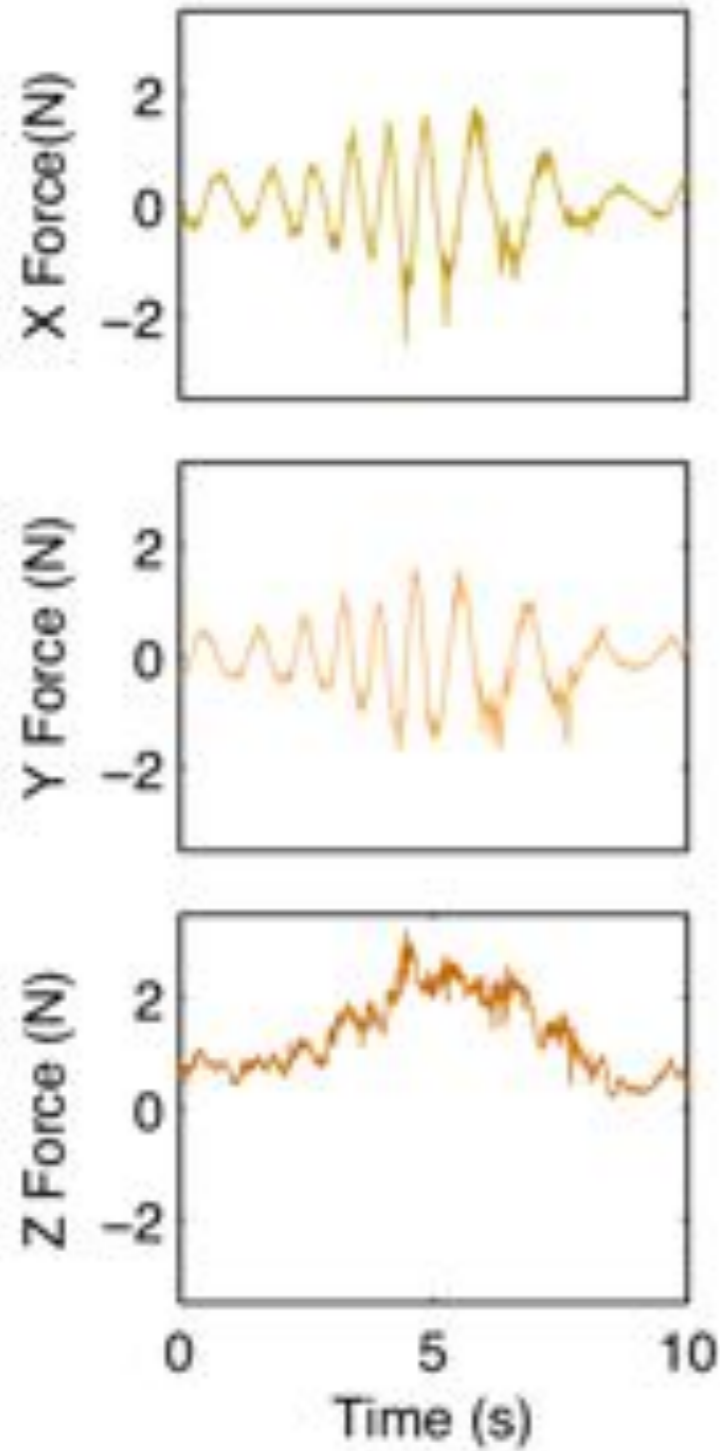

# Texture Models

- Provided in XML format
- Files used in rendering
- Two versions provided to render textures at either 10 kHz or 1 kHz sampling rate

# Texture Models

- HTML files included for visualization

## Model Set: Cork

Kinetic Friction Coefficient: **0.58**

Sampling Rate: **1000 Hz**

Number of models: **45**

Number of AR coefficients: **19**

Number of MA coefficients: **17**

Model Output Units: **m/s<sup>2</sup>**

Max speed: **248.0 mm/s**

Max force: **2.317 N**



# Texture Models

- HTML files included for visualization

## Model 12

Model Speed: 72.9 mm/s

Model Force: 0.636 N

Model Variance: 0.0171

### AR Model Parameters:

AR Coefficient	Lag
1.000000	$z^0$
-0.836382	$z^{-1}$
-0.226221	$z^{-2}$
0.150596	$z^{-3}$
-0.189633	$z^{-4}$
-0.157020	$z^{-5}$
0.328061	$z^{-6}$
-0.002168	$z^{-7}$
0.149708	$z^{-8}$

AR Line Spectral Frequency
0.068014
0.136730
0.321912
0.495069
0.649677
0.811298
1.128060
1.206881
1.247197
1.490397
1.617659

# Texture Models

- HTML files included for visualization

## Delaunay Triangulation

Model Vertex 1	Model Vertex 2	Model Vertex 3
2	7	9
15	19	27
26	27	34
32	34	36
27	30	39
4	11	15
33	35	43
16	17	20
18	27	30
7	10	12
1	2	9
7	9	12
3	4	10
2	3	7
10	11	12
3	7	10
11	12	19
9	12	14
11	15	19
4	10	11

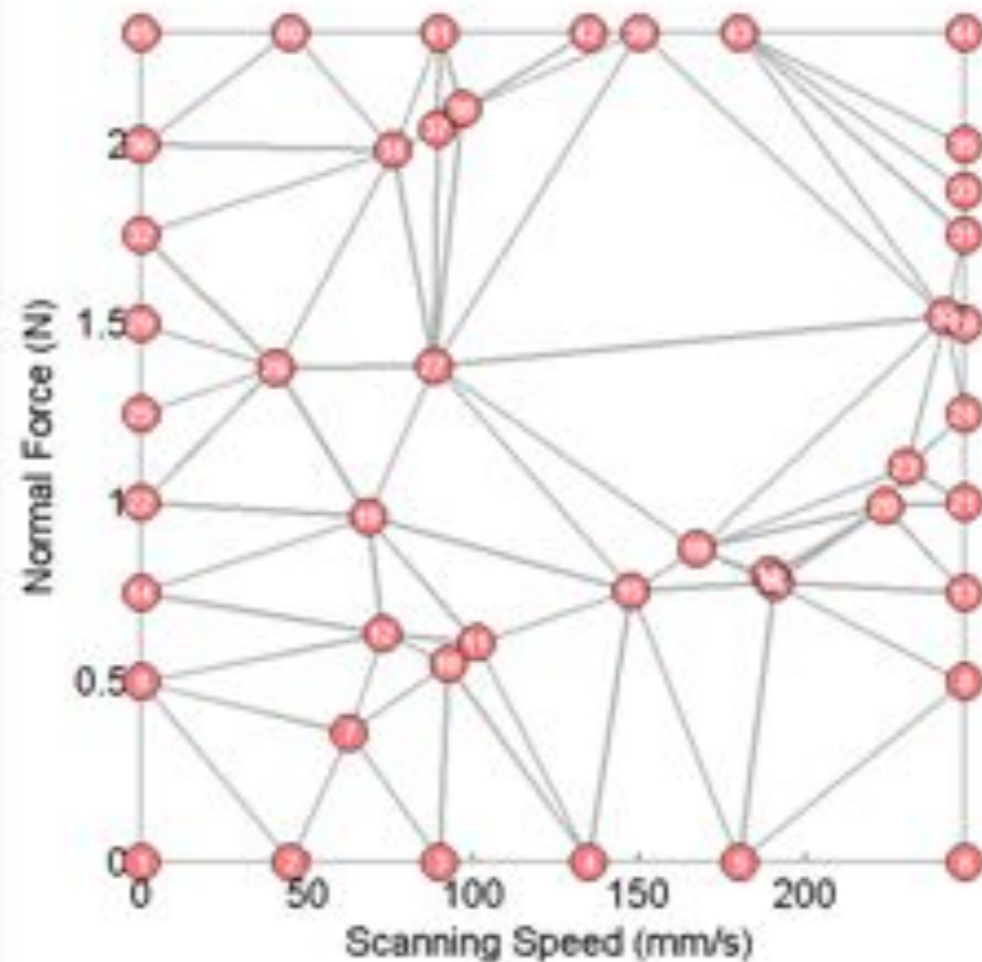



# Model Resampling Code

- Resample models to render textures at sampling rate less than 10 kHz
- Zero-order hold on inputs
  - Models become autoregressive moving-average (ARMA)
- Spectral density is constant
  - Model variance must be scaled

$$var_2 = \frac{F_{s,2}}{F_{s,1}} (var_1)$$

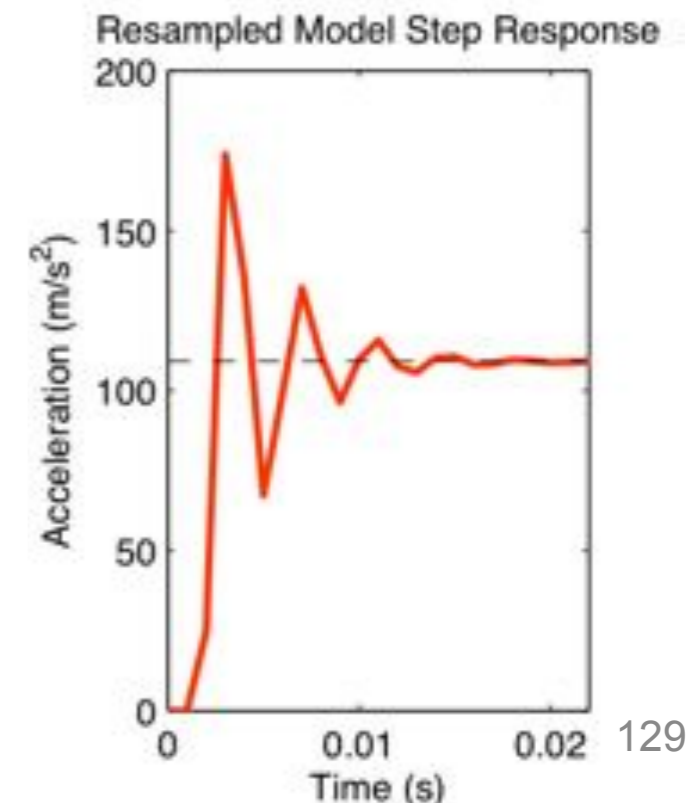
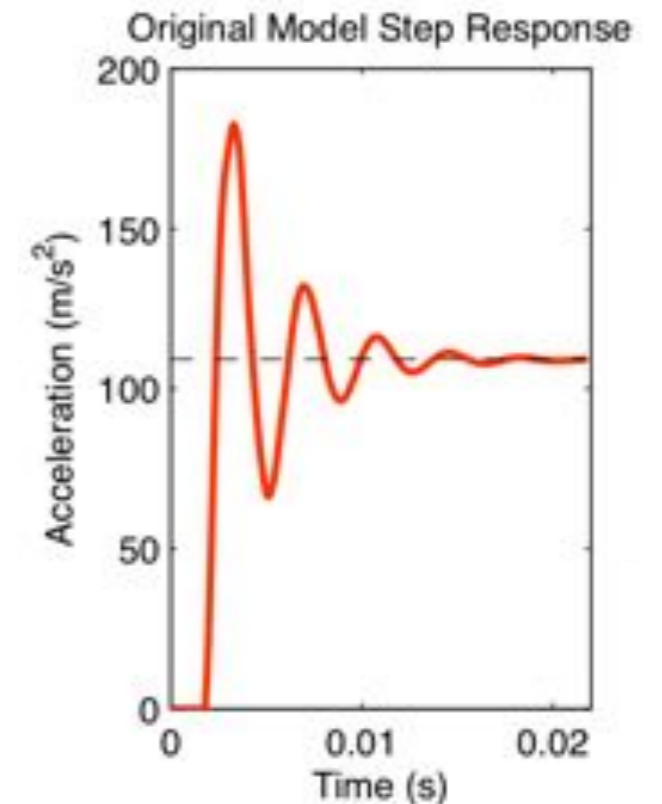

# ARMA Model Structure

- Model contains both poles and zeros
  - AR coefficients  $\{A_1, A_2, \dots, A_p\}$
  - MA coefficients  $\{C_1, C_2, \dots, C_q\}$
- Discrete-time transfer function:

$$H(z) = \frac{\sum_{k=0}^q C_k z^{-k}}{1 - \sum_{k=1}^p A_k z^{-k}}$$

# Rendering Code

- OpenHaptics 3.0, Haptic Device API (HDAPI)
- 1000 Hz haptic loop
- Available for Windows and Linux computers



# Speed Estimate

- Discrete-time derivative of proxy position
- Low-pass filtered at 20 Hz
  - Reduce noise
  - Remove movement caused by displaying texture

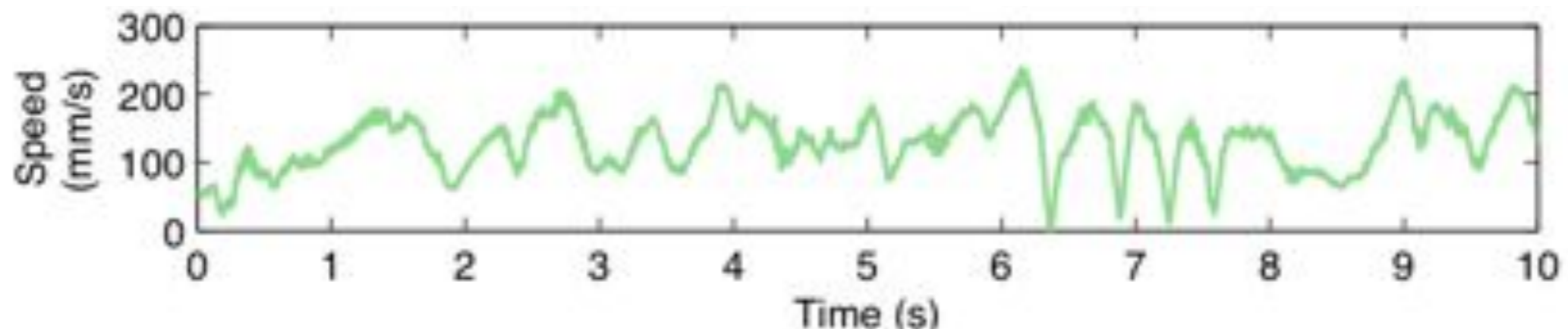

# Calculating Forces

- Normal force
  - Provides general shape and hardness
  - Follows Hooke's law relationship to proxy's penetration depth
    - Gain = 0.05 N/mm

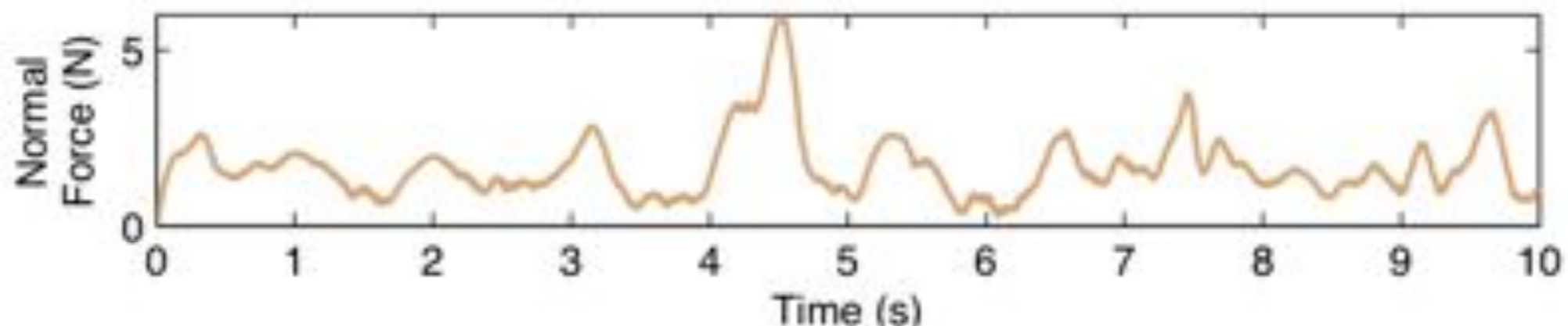

# Calculating Forces

- Friction Force
  - Uses modeled Coulomb friction coefficient
  - Modified Coulomb friction model

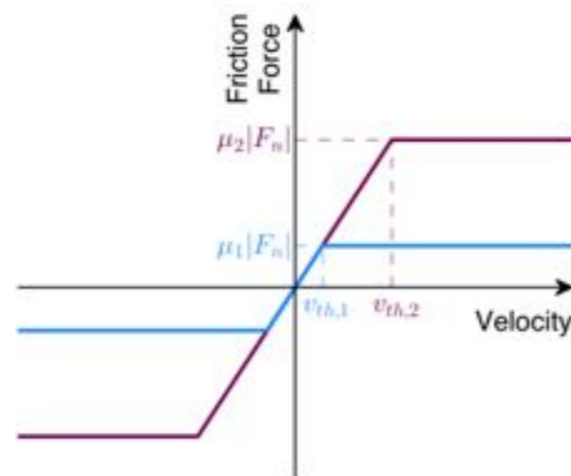

$$v_{th} = \frac{\mu_k}{b}$$

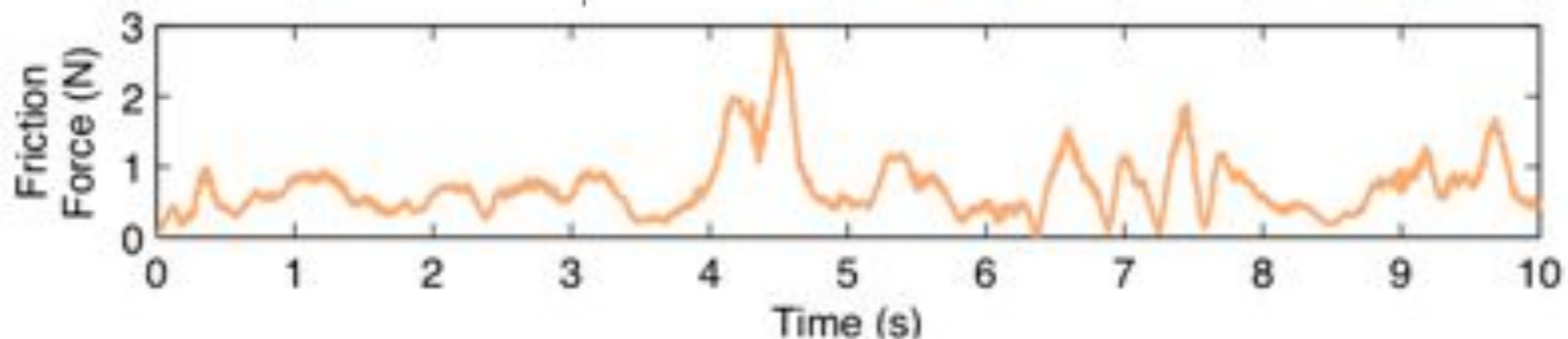

# Calculating Forces

- Texture Force
  - Vibrations synthesized at 1000 Hz
  - Scale acceleration by effective mass
    - $m_{eff} = 0.05$  kg

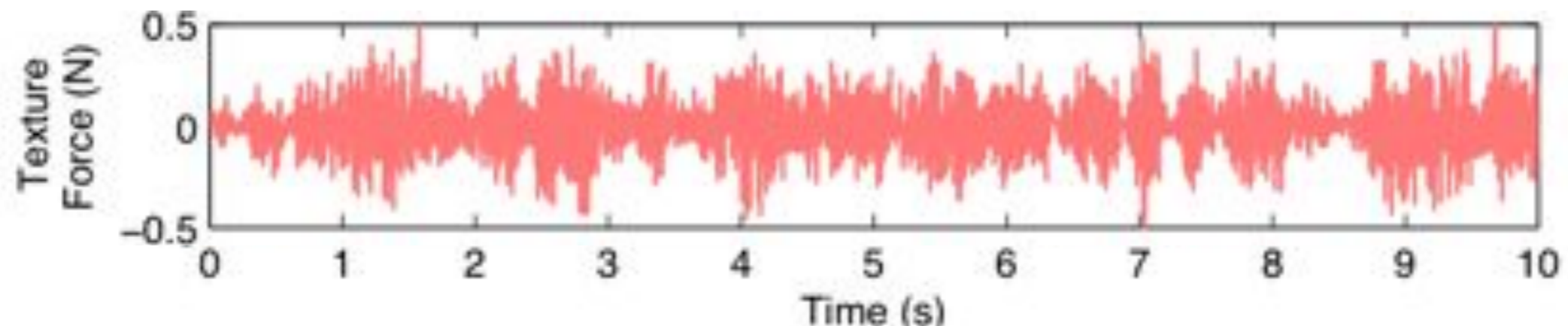

# Calculating Forces

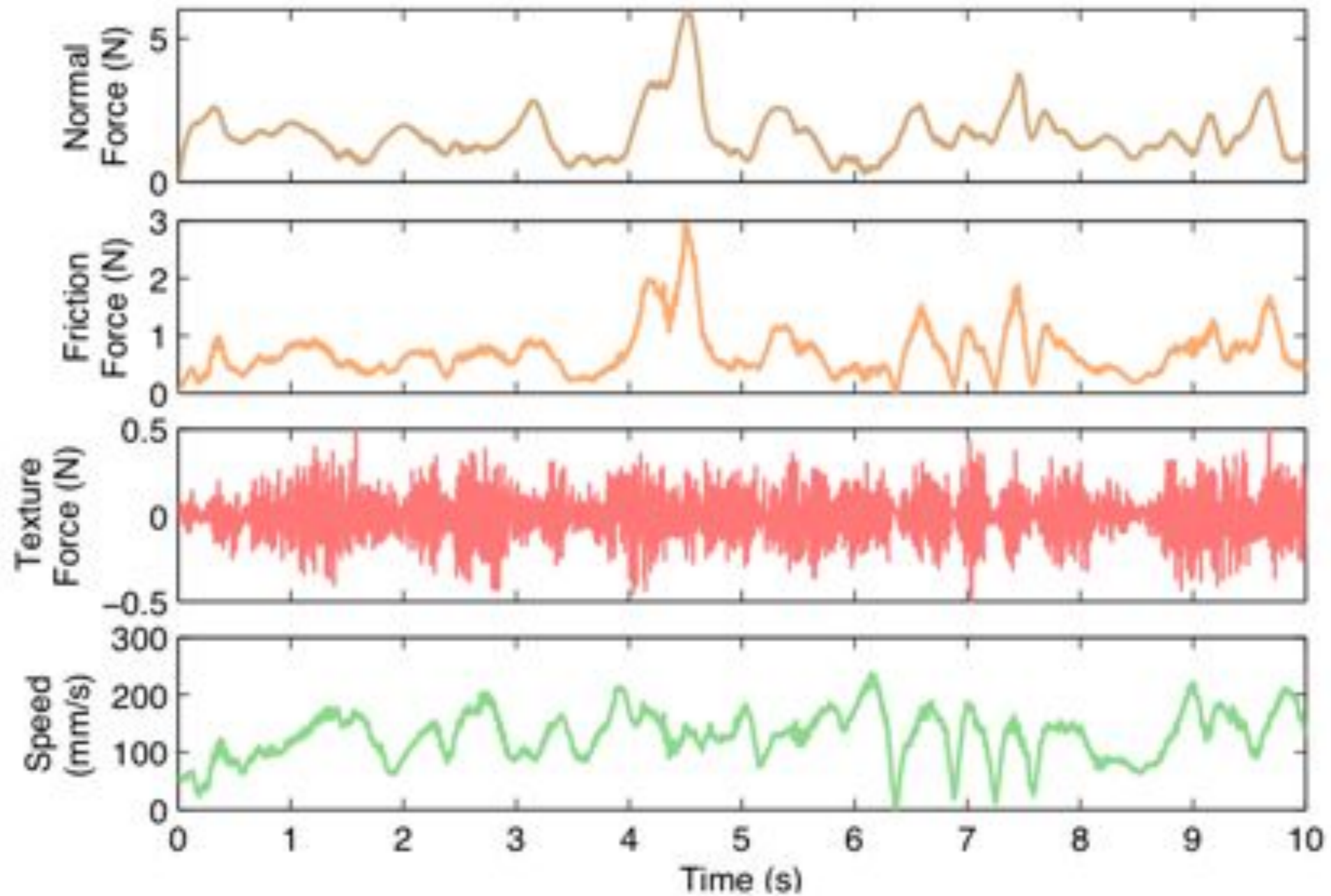



# Rendering Forces

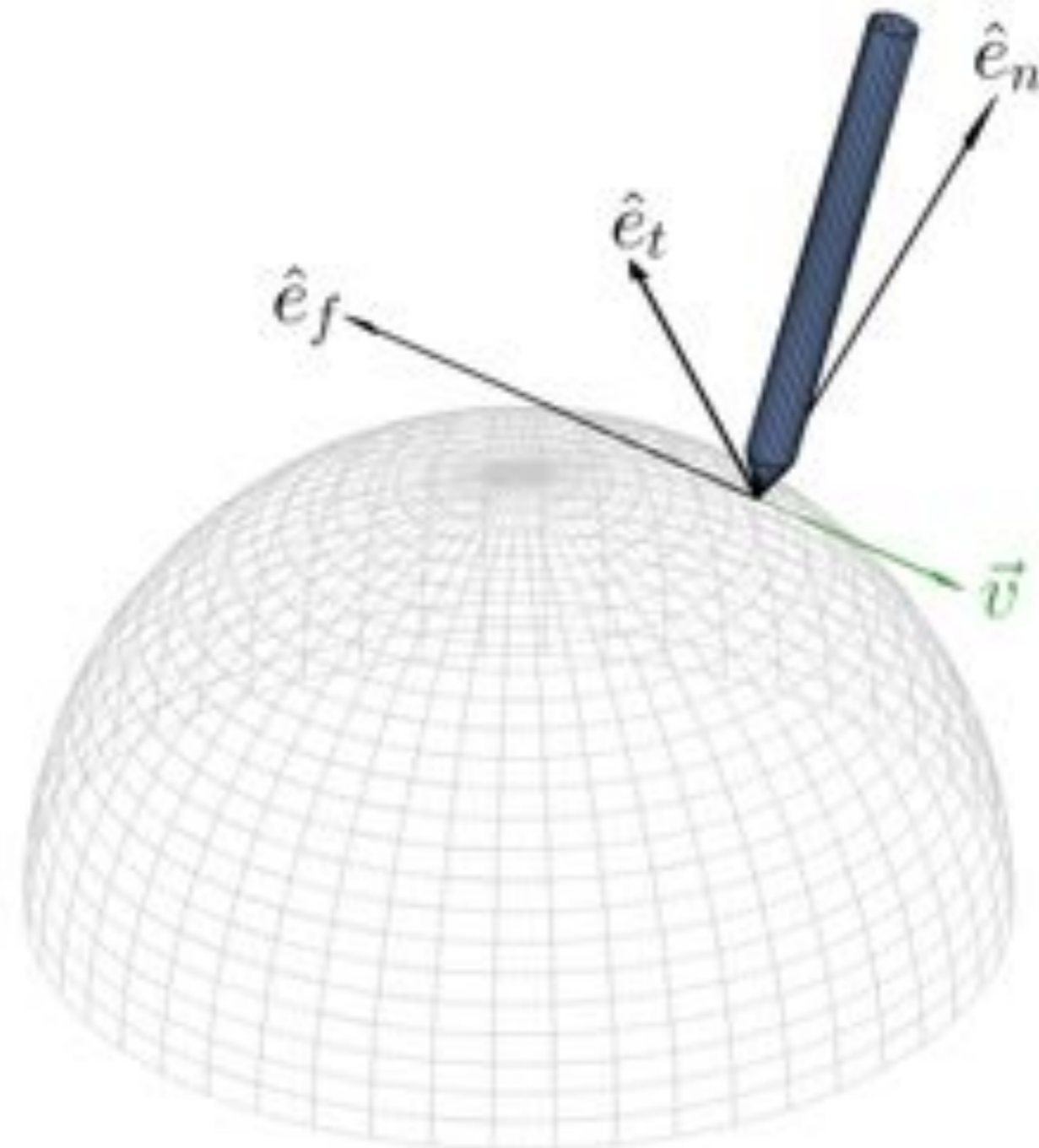

[11] Heather Culbertson, Juan José López Delgado, and Katherine J. Kuchenbecker. One hundred data-driven haptic texture models and open-source methods for rendering on 3D objects. In *Proc. IEEE Haptics Symposium*. February 2014. **Poster 11 & Demo 11**

# Demonstration 3: Toolkit Textures on Omni

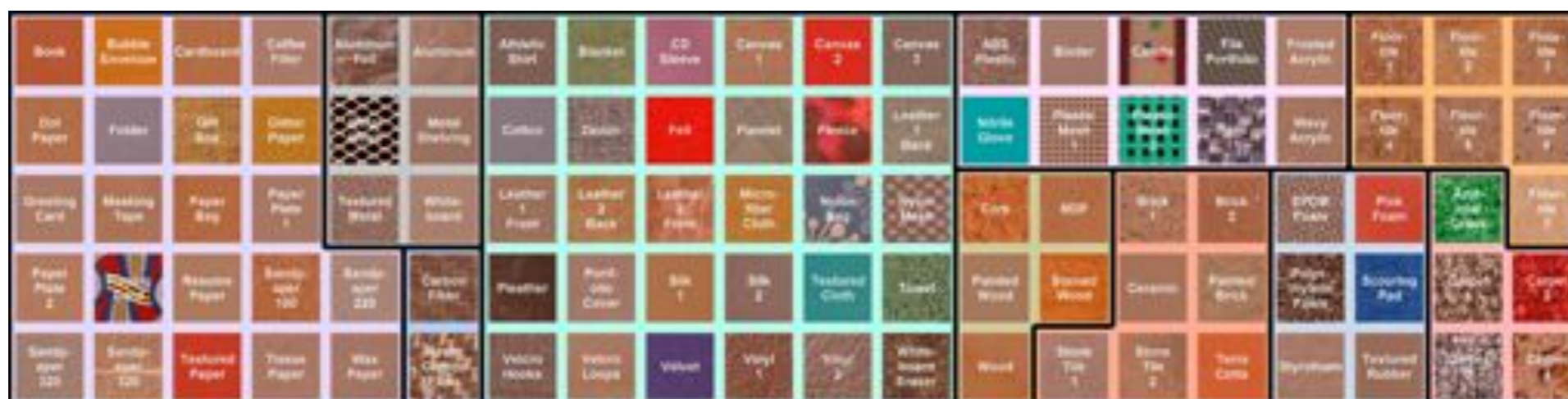

# Demonstration 3: Toolkit Textures on Omni

What questions do you have?

# Download the Toolkit

[http://repository.upenn.edu/meam\\_papers/299/](http://repository.upenn.edu/meam_papers/299/)





# SCHOLARLYCOMMONS

Collections by Research Unit | E-Journals | Thesis/Dissertations | Researcher Profiles

Enter search terms:

 Search

in this series

Advanced Search

Notify me via email or RSS

### CONTRIBUTE

Why Contribute to Scholarly Commons?

Instructions for Submitting

Create Researcher Profile

Author Help

Submit Research

### BROWSE

Collections

Subjects

Authors

Dissertations

### GENERAL INFORMATION

About

FAQ

Home > SEAS > MEAM > MEAM\_Papers > 299

Next >



## DEPARTMENTAL PAPERS (MEAM)

### The Penn Haptic Texture Toolkit for Modeling, Rendering, and Evaluating Haptic Virtual Textures

Download

[Heather Culbertson, University of Pennsylvania](#)

Follow

[Juan Jose Lopez Delgado, University of Pennsylvania](#)

Follow

[Katherine J. Kuchenbecker, University of Pennsylvania](#)

Follow

Included in  
Applied Mechanics  
Commons, Electro-  
Mechanical Systems  
Commons

Document Type

Other

SHARE

Author Help  
Submit Research

**BROWSE**

Collections  
Subjects  
Authors  
Dissertations

**GENERAL INFORMATION**

About  
FAQ  
Contact Us

**LINKS**

MEAM Website  
About  
Related Links

# The Penn Haptic Texture Toolkit for Modeling, Rendering, and Evaluating Haptic Virtual Textures

[Download](#)

[Heather Culbertson, University of Pennsylvania](#)

[Follow](#)

[Juan Jose Lopez Delgado, University of Pennsylvania](#)

[Follow](#)

[Katherine J. Kuchenbecker, University of Pennsylvania](#)

[Follow](#)

Included in  
[Applied Mechanics  
Commons](#), [Electro-  
Mechanical Systems  
Commons](#)

SHARE



## Document Type

Other

## Date of this Version

2-12-2014

## Comments

Please fill in your information [on this form](#) to be contacted about updates or bugs.

Data files updated 12/17/2013.

Rendering files updated and support for Windows application added 2/12/2014.

## Abstract

The Penn Haptic Texture Toolkit (HaTT) is a collection of 100 haptic texture and friction models, the recorded data from which the models were made, images of the textures, and the code and methods necessary to render these textures using an impedance-type haptic device such as a SensAble Phantom Omni. This toolkit was developed to provide haptics researchers with a method by which to compare and validate their texture modeling and rendering methods. The included rendering code has the additional benefit of allowing others, both researchers and designers, to incorporate our textures into their virtual environments, which will lead to a richer experience for the user.

## Keywords

haptic texture rendering, haptics, virtual reality

Related Links

Data files updated 12/17/2013.

Rendering files updated and support for Windows application added 2/12/2014.

**Abstract**

The Penn Haptic Texture Toolkit (HaTT) is a collection of 100 haptic texture and friction models, the recorded data from which the models were made, images of the textures, and the code and methods necessary to render these textures using an impedance-type haptic device such as a SensAble Phantom Omni. This toolkit was developed to provide haptics researchers with a method by which to compare and validate their texture modeling and rendering methods. The included rendering code has the additional benefit of allowing others, both researchers and designers, to incorporate our textures into their virtual environments, which will lead to a richer experience for the user.

**Keywords**

haptic texture rendering, haptics, virtual reality

**Additional Files**

[license.pdf](#) (68 kB)

*Copyright and permission notice*

[RecordedData\\_Models.zip](#) (561736 kB)

*Recorded data used to make texture models*

[RecordedData\\_Friction.zip](#) (569110 kB)

*Recorded data used to make friction models*

[TextureModels.zip](#) (176955 kB)

*Texture model files and images*

[RenderingCode\\_Linux.zip](#) (170661 kB)

*Texture rendering files for Linux computers*

[RenderingCode\\_Windows.zip](#) (170567 kB)

*Texture rendering files for Windows computers*

**Date Posted:** 30 September 2013

# Acknowledgments

NSF Graduate Research Fellowship  
under Grant #DGE-0822



NSF #IIS-0845670: “CAREER: Haptography: Capturing  
and Recreating the Rich Feel of Real Surfaces”



University of Pennsylvania  
students and colleagues







# Thank You



Katherine J. Kuchenbecker  
kuchenbe@seas.upenn.edu

Heather Culbertson  
hculb@seas.upenn.edu

<http://haptics.grasp.upenn.edu>